

Owner's Manual

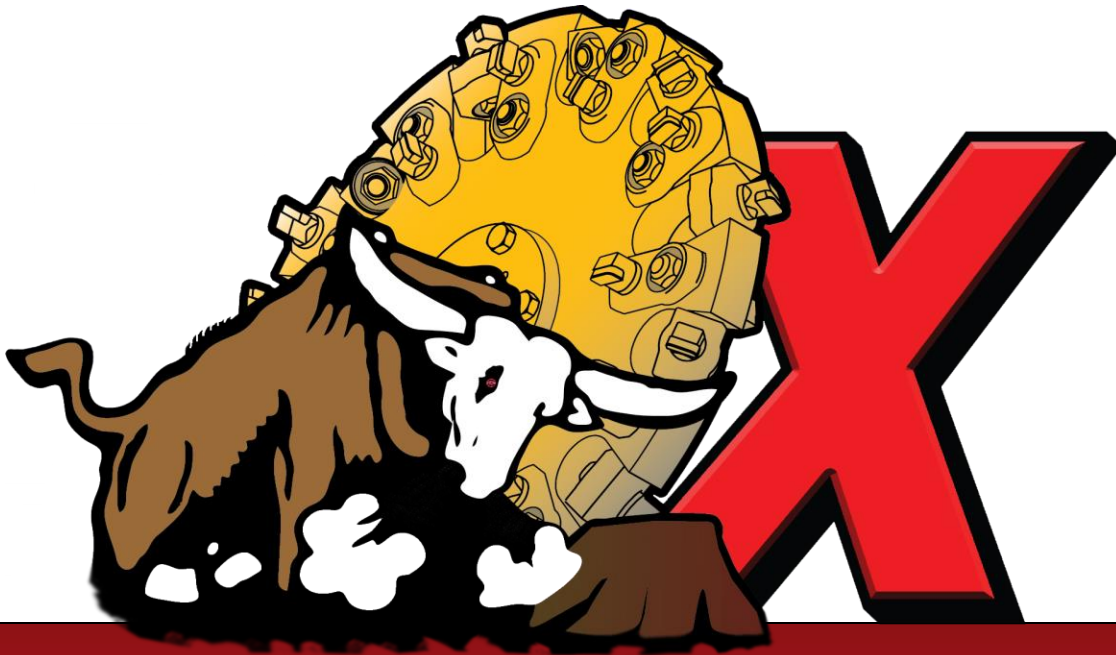

SP7015 SERIES

Machine Serial # _____
Engine Model & Spec # _____
Engine Serial # _____
Purchase Date _____
Dealer _____

REVISION: 210107-1



J.P. Carlton Company
Div. D.A.F. Inc.
121 John Dodd Road
Spartanburg, SC 29303
Ph. (864) 578-9335
Fax (864) 578-0210
www.stumpcutters.com

BLANK SHEET

 **WARNING**

This product and the fuels used to operate this product (Gasoline or Diesel), and the products of combustion of such fuels, can expose you to chemicals including benzene, which is known to the State of California to cause cancer, birth defects, or other reproductive harm.

For more information go to www.p65Warnings.ca.gov



⚠ DANGER

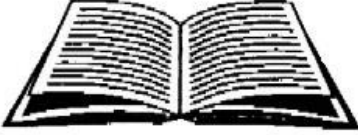

No inexperienced person may operate machine. Inexperience may cause injury.
Read operation manual.

⚠ WARNING



Loud noise. Flying debris.
Hearing and eye protection must be worn while in operation.

⚠ DANGER



Pinch Points
Keep body parts away while in operation.

JPC09

⚠ DANGER



Stay clear while machine is in operation.
Cutter wheel will cause severe injury or death.

JPC27



⚠ WARNING

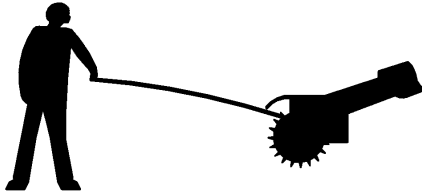

**OPERATE MACHINE FROM
25 FEET AWAY.
KEEP SPECTATORS AWAY.**

⚠ WARNING



**This machine may tip over
sideways if operated on
non-level surface.
Always use caution when
operating on non-level
surface.**

⚠ WARNING

**IF THIS EQUIPMENT
IS TURNED OVER, YOU
WILL CAUSE ENGINE
DAMAGE, HYDRAULIC
DAMAGE, AND
POSSIBLE PERSONAL
INJURY.**

JPC38



⚠ WARNING



**SEVERE ENGINE DAMAGE
WILL OCCUR IF THIS
ENGINE IS OPERATED AT
AN ANGLE GREATER
THAN 25°**

**PROPER ENGINE OIL LEVEL
MUST BE MAINTAINED TO
ACHIEVE MAXIMUM ANGLE OF
OPERATION OF 25°
(SEE ENGINE OWNER'S MANUAL
FOR PROPER OIL LEVEL)**

0700075A

 <h1 style="margin: 0;">DANGER</h1>
<p>DO NOT MOVE, POSITION, OR TRANSPORT THIS MACHINE WHILE THE CUTTERWHEEL IS ENGAGED.</p>
JPC80

	<p>WARNING (AVISO) (AVERTISSEMENT)</p> <p>TO PREVENT SERIOUS INJURY OR DEATH FROM MOVING PARTS: * KEEP HANDS, FEET, AND CLOTHING AWAY FROM MOVING PARTS. * CLOSE ALL GUARDS AND SHIELDS BEFORE OPERATING MACHINERY.</p> <p>PARA EVITAR LA LESION O LA MUERTE: * MANTENGANSE A DISTANCIA LAS MANOS, LOS PIES Y LA ROPA DE LAS PARTES MOVIMIENTOS DE LA MAQUINA. * CIERRAN TODAS LAS PROTECTORAS QUE HAY ANTES QUE HAGAN FUNCIONAR.</p>
	<p>AFIN D'ÉVITER TOUTE BLESSURE GRAVE OU LA MORT: * NE PAS RAPPROCHER LES MAINS, LES PIEDS OU LES VÊTEMENTS DES PIÈCES MOBILES. * S'ASSURER QUE TOUTES LES PIÈCES DE PROTECTION SONT EN PLACE AVANT DE METTRE EN MARCHÉ LA MACHINERIE.</p>

	<p>WARNING (AVERTISSEMENT) (AVISO)</p>
	<ul style="list-style-type: none"> • THREAD FULLY • TIGHTEN NUT
<ul style="list-style-type: none"> • ENROSCAR COMPLETAMENTE • APRETAR TUERCA 	<ul style="list-style-type: none"> • VISSER À FOND • SERRER L'ÉCROU

<h1 style="margin: 0;">NOTICE</h1>
<p>SERVICING BELTS AND BEARINGS</p>
<p>ALWAYS TURN OFF ENGINE AND REMOVE KEY BEFORE SERVICING! ALLOW ALL PARTS TO COME TO A COMPLETE STOP AND COOL BEFORE TOUCHING!</p>
<ul style="list-style-type: none"> • New belts stretch and get loose. After 2 hours of operation, check tension and tighten belts. • Check tension and retighten every 4 hours of operation until tension stays consistent. • See manual for instruction and proper tension. • Thereafter, check belt tension every month until belts need replacing.
<p>AT LEAST ONCE A MONTH:</p> <ul style="list-style-type: none"> • CHECK AND TIGHTEN BOLTS AND LOCK SETSCREWS ON ALL BEARINGS. • CHECK AND TIGHTEN SCREWS ON ALL BELT PULLEY BUSHINGS.
<p>REFER TO MAINTENANCE SECTION</p>
0700311

<h1 style="margin: 0;">NOTICE</h1>
<p>Premature engine failure could occur without proper maintenance of outboard bearing. See manual for further information.</p>
JPC

<h1 style="margin: 0;">NOTICE</h1>
<p>DECALS SHOULD BE PROPERLY MAINTAINED AND REPLACED. IT IS THE DUTY OF THE OWNER OF THIS EQUIPMENT TO KEEP DECALS IN GOOD CONDITION.</p>
<p>REPLACEMENT DECALS MAY BE PURCHASED FROM J. P. CARLTON CO.</p>
0700309



⚠ WARNING



FLAMMABLE FUEL

THIS MACHINE USES FLAMMABLE FUEL AND HYDRAULIC OIL.

NEVER FILL TANK WHILE ENGINE IS HOT, RUNNING, OR IN A CONFINED AREA. DANGER OF FIRE OR EXPLOSION EXIST.

LEAVE ROOM IN THE TANK FOR EXPANSION FROM HEAT - NEVER FILL TANK COMPLETELY FULL.

KEEP MACHINE AWAY FROM FIRE, SPARKS, AND OTHER SOURCES OF IGNITION DURING USE AND STORAGE.

NEVER PUT MACHINE IN STORAGE WITH FUEL IN THE TANK.

ALWAYS STORE FUEL IN APPROVED CONTAINERS AND AWAY FROM SOURCES OF IGNITION.

0700316

⚠ WARNING



KEEP AWAY FROM PRESSURIZED LEAKS

Pressurized leaks are not always visible. Check for pressurized leaks using cardboard or wood. Never use a finger, hand or other body part to check for leaks.

Injuries from pressurized leaks penetrating the skin will lead to serious health problems or death. CONSULT A PHYSICIAN IMMEDIATELY IF PENETRATION OCCURS, SURGICAL REMOVAL REQUIRED.

Release pressure from line before loosening, removing or replacing any hydraulic hoses or equipment.

0700317

⚠ WARNING

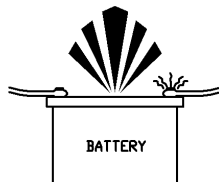

**USE CAUTION IN
EXTREME COLD!
FROZEN BATTERY
WILL EXPLODE!**

NEVER JUMP START A BATTERY IN FREEZING TEMPERATURES. INSPECT BATTERY FOR SIGNS OF FROST BEFORE STARTING IN EXTREME COLD. MOVE EQUIPMENT TO A HEATED, WELL VENTILATED AREA TO ALLOW BATTERY TO THAW BUT NOT NEAR FIRE, SPARKS, OR OTHER SOURCES OF IGNITION.

BATTERY FUMES ARE EXPLOSIVE. NEVER USE JUMPER CABLES OR RECHARGE BATTERY UNLESS IN AN OPEN OR WELL VENTILATED AREA AND AWAY FROM ALL SOURCES OF IGNITION.

BATTERY ACID CAN CAUSE SEVERE BURNS. KEEP AWAY FROM EYES, SKIN, AND CLOTHING.

ALWAYS REMOVE BATTERY BEFORE WELDING ON EQUIPMENT. FOLLOW PROCEDURES FOR WELDING AND GROUNDING BEFORE STARTING TO WELD ON THIS MACHINE OR EQUIPMENT DAMAGE AND POSSIBLY SEVERE PERSONAL INJURY WILL OCCUR.

0700314



STUMP GRINDER LIMITED WARRANTY

J.P. Carlton Co. Inc., hereafter referred to as the “Manufacturer”, warrants each new Carlton Grinder to be free of defects in workmanship and material for a period of one year.

This warranty takes effect upon delivery to the original retail purchaser. The manufacturer, at its option, will replace or repair, at a point designated by the manufacturer, any parts which appear to have been defective in material or workmanship. The manufacturer is not responsible for consequential damages.

This warranty will not apply if the grinder is not operated in a manner recommended by the manufacturer. The following examples would void warranty:

1. The grinder has been abused.
2. The machine is involved in or damaged by an accident.
3. Repairs or attempted repairs were made without prior written authorization.
4. Including but not limited to repairs made due to normal wear.

The owner is responsible for all regular maintenance as explained in the operators’ manual. Neglect in regular maintenance or failure to replace normal wear items such as teeth, pockets, lubrication oils, filters, belts, bearings, etc. may void warranty.

This warranty is expressly in lieu of any other warranties, expressed or implied, including any implied warranty or merchantability of fitness for a particular purpose and of any non-contractual liabilities including product liabilities based upon negligence or strict liability. J.P. Carlton Co. Inc. will not be liable for consequential damages resulting from breach of warranty.

IT IS NECESSARY TO RETURN THE WARRANTY VALIDATION FORM AND NOTIFY J.P. CARLTON CO. INC. IN WRITING WITHIN TEN (10) DAYS FROM DELIVERY DATE TO VALIDATE THIS WARRANTY.

NOTE: This warranty applies only to new and unused equipment or parts thereof manufactured by J.P. Carlton Co. Inc. ANY MACHINES USED FOR LEASE OR RENTAL - WARRANTY IS LIMITED TO 90 DAYS FROM FIRST DAY OF INITIAL SERVICE.

NOTICE: All power units and associated components are NOT warranted by J.P. Carlton Co. Inc. or their dealers. It is the customers’ responsibility to return machine to the local engine distributor.

INFORMATION PHONE NUMBERS TO FIND YOUR LOCAL ENGINE & PARTS SERVICE CENTERS:

- Honda 1-770-497-6400 (GA-Eastern Time Zone)
- Kohler Engines..... 1-800-544-2444 (Toll Free)
- Briggs & Stratton Engines 1-800-233-3723 (Toll Free)
- Deutz Engines..... 1-800-241-9886 (Toll Free)
- John Deere Engines 1-800-533-6446 (Toll Free)
- Caterpillar 1-877-636-7658 (Toll Free)
- Kubota 1-847-955-2500 (IL-Central Time Zone)
- Kawasaki Engines..... 1-616-949-6500 (MI-Eastern Time Zone)
- Wisconsin Engines 1-800-932-2858 (Toll Free)
- Onan Engine..... 1-800-888-6626 (Toll Free)

In order to process any warranty claims, it is the owners’ responsibility to report claims promptly to us or our authorized dealer from whom the equipment was purchased. It is necessary to include the following information on any and all request for warranty:

- | | |
|-------------------------------|----------------------------------|
| 1. Dealer from whom purchased | 5. Engine make and serial number |
| 2. Date of delivery | 6. Length of time in use |
| 3. Serial number of unit | 7. Date of failure |
| 4. Model number of unit | 8. Nature of failure |



STUMP GRINDER LIMITED WARRANTY

EXPLANATION OF LIMITED WARRANTY

The manufacturer will not reimburse the customer or dealer labor cost incurred for installing “bolt-on” or “slip-on” items, such as pumps and motors, bearings, belts, pulleys, etc. The manufacturer will provide replacement parts at no cost to the customer for defective parts during the warranty period. Defective parts must be returned to J.P. Carlton Company. It will be the customers’ responsibility to install the replacement parts unless arrangements are made with the selling dealer.

The manufacturer will not reimburse travel cost to servicing dealer. It is the customers’ responsibility to deliver machine to dealers facility, unless other arrangements have been agreed to between the selling dealer and the customer.

The manufacturer may elect, at its discretion, to reimburse reasonable labor cost to customer or dealer for major defect repairs. Prior approval must be obtained from J.P. Carlton Company Inc.

IMPORTANT NOTICE

- 1. AIR FILTER MAINTENANCE IS CRITICAL ON STUMP GRINDING MACHINES. DIRT INGESTION WILL NOT BE WARRANTED BY THE ENGINE MANUFACTURER OR J.P. CARLTON COMPANY.**
- 2. OIL AND OIL FILTER MAINTENANCE AND STAYING WITHIN THE LIMITS OF THE ANGLE OF OPERATION IS ALSO CRITICAL ON STUMP GRINDING MACHINES. STARVING THE ENGINE FOR OIL WILL NOT BE WARRANTED BY THE ENGINE MANUFACTURER OR J.P. CARLTON COMPANY.**
- 3. FAILURE TO MAINTAIN OUTBOARD BEARING CAN CAUSE ENGINE FAILURE.**

BLANK SHEET

Warranty Validation Form

Congratulations on your purchase of a Carlton Stump Grinder. This product has been designed and manufactured to provide years of profitable service while minimizing maintenance and downtime. Please take the time now to complete this warranty validation form. This information is necessary for Carlton to instate your warranty.

Return Form To: J.P. Carlton Company, Div. D.A.F. Inc.
121 John Dodd Road
Spartanburg, SC 29303
Phone: 1-864-578-9335

Purchaser Information:

Company Name: _____ Street Address: _____
City: _____ State: _____ Zip Code: _____
Telephone: _____ Contact: _____

Machine Information:

Model Number : _____ Engine Model : _____
Serial Number : _____ Serial Number : _____

Dealer Information:

Dealer Name: _____ Street Address: _____
City: _____ State: _____ Zip Code: _____
Contact Name: _____

1. _____ Customer has been instructed on operation and safety aspects of operating the equipment.
2. _____ Customer has been advised not to reach into cutter wheel area.
3. _____ Customer has been advised to stop machine and remove key before performing any type of maintenance.
4. _____ Customer has been warned not to operate the machine without the cutter wheel guard in place.
5. _____ Customer has been furnished with all parts and operators manuals.
6. _____ Customer has been instructed on equipment maintenance schedules and procedures.
7. _____ Customer has been advised that the engine or power unit that is used on this machine is warranted by the engine manufacturer and ***NOT J.P. Carlton Company***. All engine warranty issues should be addressed to the local engine dealer.
8. _____ Customer understands the importance of air and oil filter maintenance, and the importance of staying within the angle of operation of the engine. If either of these is not adhered to, the engine warranty is ***VOID***.
9. _____ Customer understands to keep locking collars tight and purge bearings with grease.
10. _____ All operation and warning decals are properly displayed on equipment.
11. _____ Customer understands it is his responsibility to train all operators on operator safety.

I have inspected this equipment and find it in good working condition. To the best of my knowledge, the customer and his personnel are aware of the above procedures.

Date: _____ Signed: _____
Dealer Representative

The equipment has been thoroughly checked by the above named dealer representative, and I am satisfied with his instructions.

Date: _____ Signed: _____
Purchaser

BLANK SHEET

**INTRODUCTION**

FOREWORD	1
GENERAL INFORMATION	2
MACHINE FEATURES	3
MACHINE SPECIFICATIONS	4

OPERATION

SAFETY PRECAUTIONS	7
DAILY CHECKLIST	11
MACHINE CONTROLS	12
TRANSPORTING	20
MACHINE OPERATION	22

MAINTENANCE

MACHINE MAINTENANCE	27
TROUBLESHOOTING GUIDE	35
SERVICING CUTTER WHEEL	37
SERVICING HYDRAULICS	42
SERVICING BELTS	45
SERVICING BEARINGS	49
SERVICING STUB SHAFT	51
SERVICING REAR END	56
CONTACT INFORMATION	
BACK	



Congratulations on your purchase of a new Carlton® Professional Stump Grinder! Carlton® Stump Grinders have a reputation for superior performance and reliability. A machine is not profitable if it's broken-down and we do our absolute *best* to help you avoid costly downtime. Each and every machine has been *over-designed* and built to ensure years and years of trouble-free operation. In this, we take pride!

Read this manual carefully and **TAKE RESPONSIBILITY** for thoroughly familiarizing yourself with the controls and the concepts behind the operation of this machine before attempting to operate it. Slowly experiment with the controls and gradually work yourself up to the full capabilities of this machine. The Carlton® Model SP7015 is a durable and profitable professional stump grinder. Read this manual, the engine manual, along with the safety and operational decals on the machine. Use proper safety precautions. Follow the instructions provided and use common sense and your "OX" will perform like its namesake. If getting more work done in a day, with less trouble, is your idea of good business, then you will love your new Carlton® Stump Grinder!

We welcome your suggestions on how we might better build our machines. We solicit any and all questions concerning the operation or proper servicing of your new stump grinder.

Please feel free to write to us with any comments.
We'll enjoy hearing from you!

The J. P. Carlton Company constantly strives to create the best equipment available in the stump cutting industry. Therefore, the material in this manual is correct at the time of publication. Carlton® reserves the right to make improvements, modifications and even discontinue features, as we deem necessary to meet our goal. Carlton® also reserves the right to discontinue models without any prior notification or obligation.

Inspect your new Carlton® Stump Grinder as soon as you receive it. Any damages incurred during shipment are not warranted and therefore not covered repairs. You should have the truck driver verify or acknowledge any damages caused during shipment. If not, contact the truck lines as soon as possible with your complaint.

Any reference made to right, left, front or rear in relationship to the stump cutter is illustrated in the following picture. Please refer to these any time you call your dealer or J. P. Carlton Company for parts or assistance.





- Diesel Power
- Wireless remote control
- Direct drive hydraulic pump
- Hydraulic Controls
- Hydraulic motor propulsion
- Hydraulic Steering
- Safety valves permit unaffected operation uphill, downhill or level
- Counter-balancing valve
- High and Low Gear control for variable travel speed
- Dual swing cylinders
- Hardened bushings in rotating cylinders
- Heavy construction
- Premium tires on the wheel version with a four-wheel stance
- Track version is hydraulically expandable to 48"
- Both versions reduce to 35" width to clear narrow fence gates
- Tapered roller bearings on cutter wheel & jackshaft
- 1" thick Blanchard ground cutter wheel
- Low maintenance drive belt
- Carbide tipped cutter teeth: Standard Cutter Wheel 32 teeth, Optional Razor Wheel 48 teeth
- Easy engine belt adjustment
- Safety tie down loops
- Epoxy primer
- Key start
- High capacity battery
- Heavy-duty rubber and metal chip guards
- Hour meter
- Large hydraulic tank
- Hydraulic and fuel filters
- Poly Chain® to cutter wheel

*We Pride Ourselves
in the Strength and Quality of Each and Every Machine.*

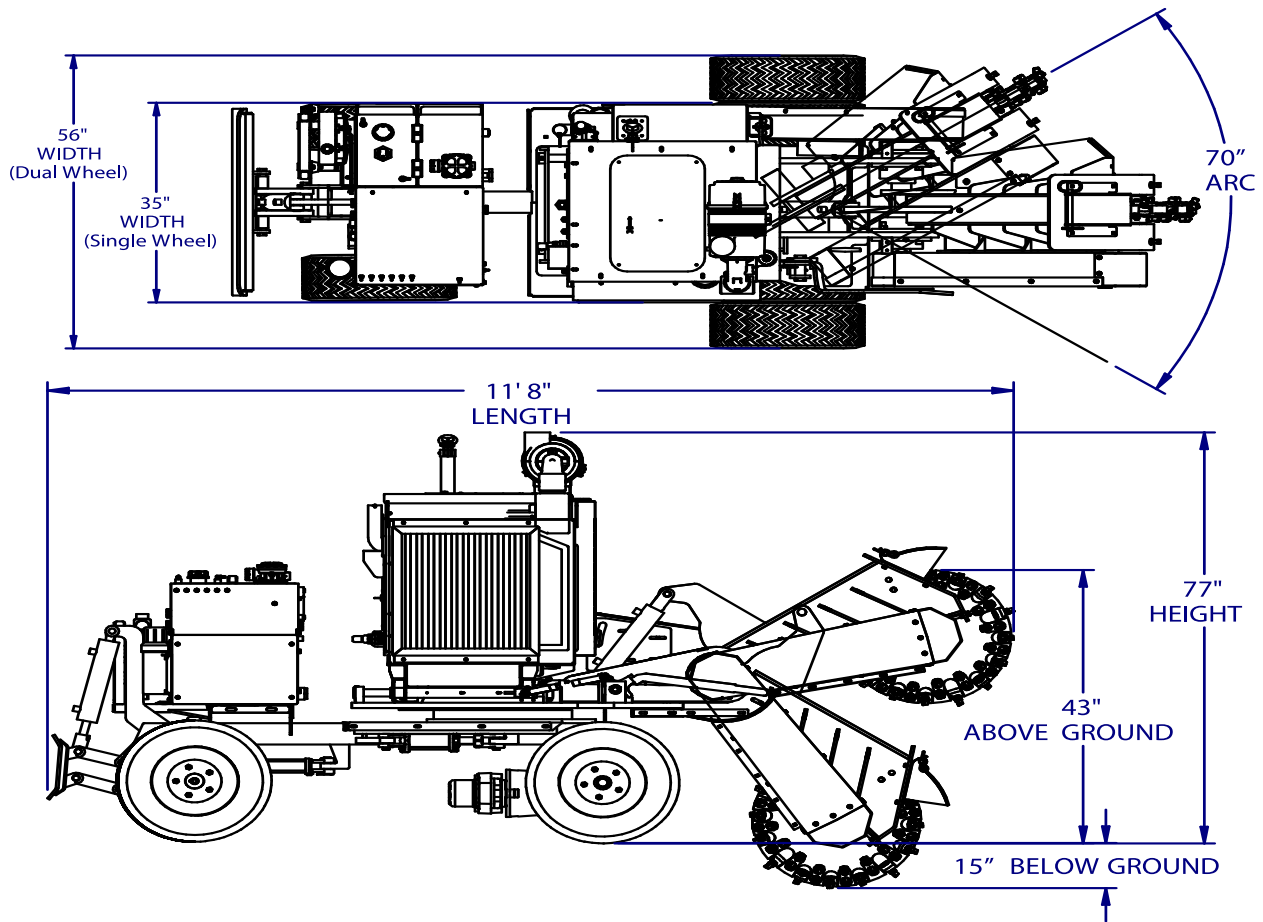

MODEL SP7015 WHEEL

Approximate Dimensions & Weights

(Dimensions & weights will vary depending on optional equipment)

*Approx. Weight:	4520 lbs. (2050.23 kg)		
Overall Dimension:	Length: 140" (355.6 cm)	**Width: 35" (88.9 cm)	Height: 77" (195.6 cm)
Cutting Depth:	15" (38.1 cm)		
Cutting Height:	43" (109.22 cm)		
Cutting Swing:	70" (177.8 cm)		
Number of Teeth on	48	Razor Wheel	
Cutter Wheel:	32	Standard Wheel	
Cutter Wheel Diameter	28" (71.12 cm)		
with Teeth:			
Fuel Tank Capacity:	9.6 Gallons (36.3 Liters)		
Hydraulic Tank Capacity:	9 Gallons (34.1 Liters)		

*Approximate weights depending on engine and optional equipment.

**Width is based on single wheel configuration.

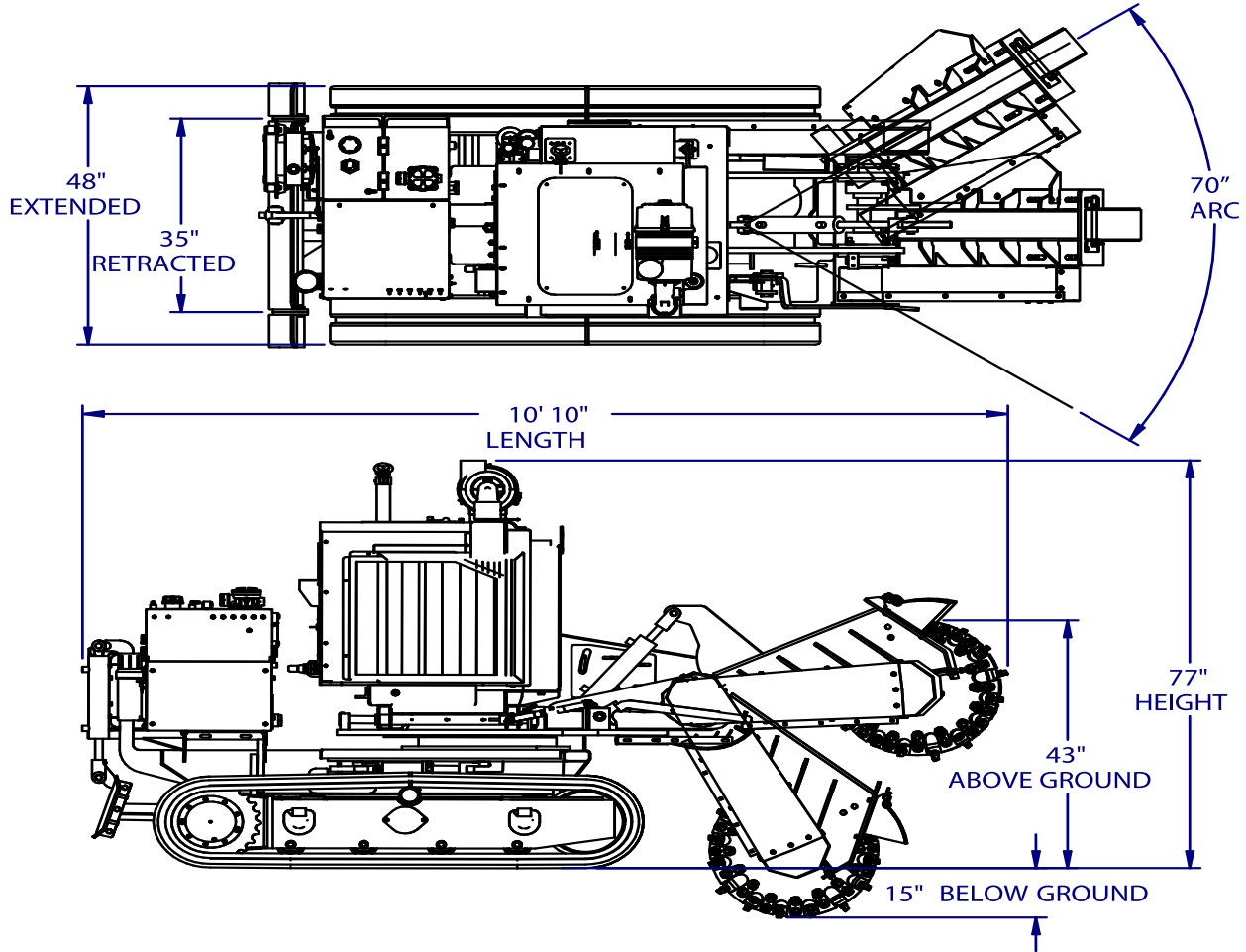

MODEL SP7015 TRACK

Approximate Dimensions & Weights

(Dimensions & weights will vary depending on optional equipment)

*Approx. Weight:	5820 lbs. (2639.90 kg)		
Overall Dimension:	Length: 130" (330.20 cm)	**Width: 35" (88.9 cm)	Height: 77" (195.6 cm)
Cutting Depth:	15" (38.1 cm)		
Cutting Height:	43" (109.22 cm)		
Cutting Swing:	70" (177.8 cm)		
Number of Teeth on	48	Razor Wheel	
Cutter Wheel:	32	Standard Wheel	
Cutter Wheel Diameter	28" (71.12 cm)		
with Teeth:			
Fuel Tank Capacity:	9.6 Gallons (36.3 Liters)		
Hydraulic Tank Capacity:	9 Gallons (34.1 Liters)		

*Approximate weights depending on engine and optional equipment.

**Width is based on retracted track configuration.

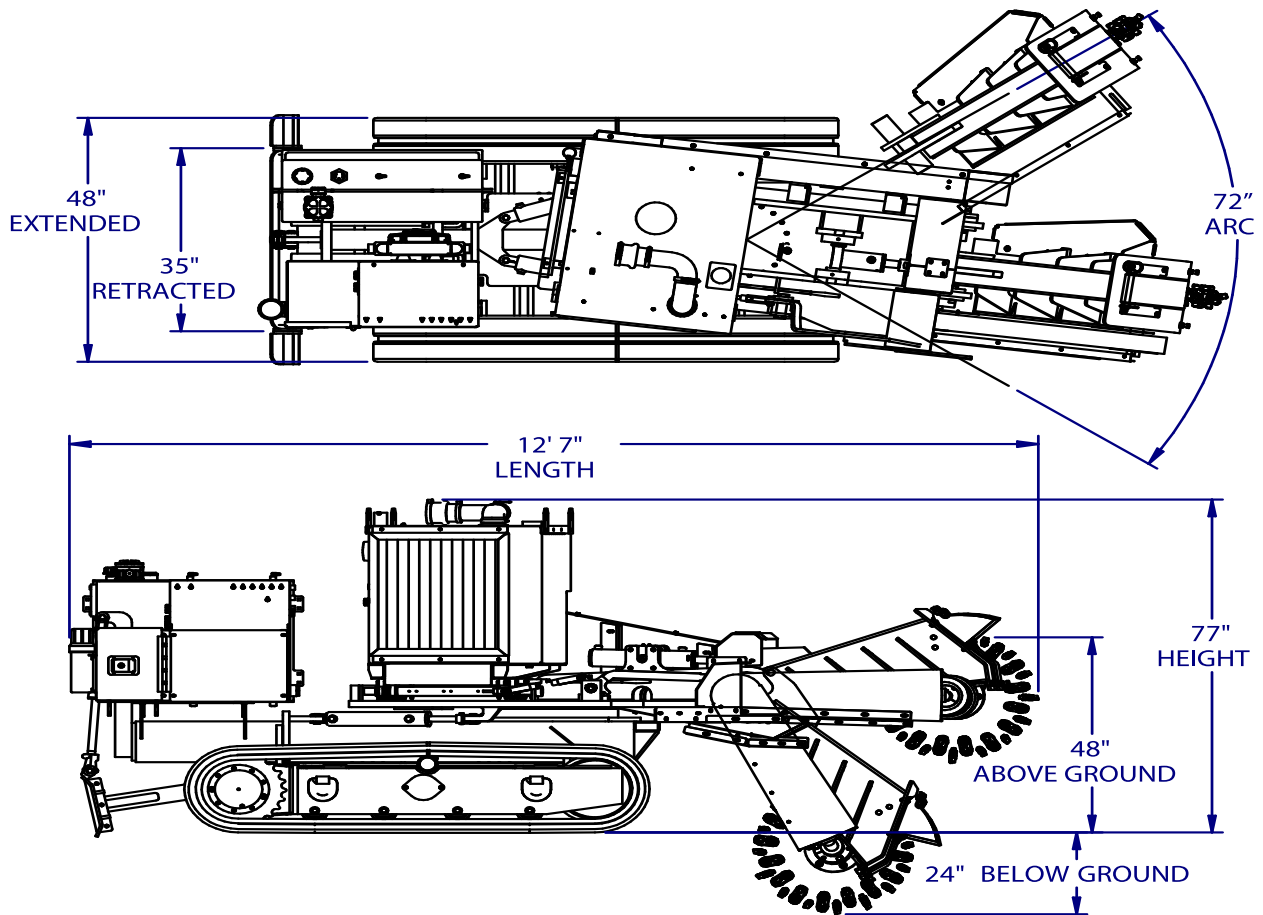

MODEL SP7015HD TRACK

Approximate Dimensions & Weights

(Dimensions & weights will vary depending on optional equipment)

*Approx. Weight:	6400 lbs. (2902.99 kg)		
Overall Dimension:	Length: 151" (383.54 cm)	**Width: 35" (88.9 cm)	Height: 77" (195.6 cm)
Cutting Depth:	24" (60.96 cm)		
Cutting Height:	48" (121.92 cm)		
Cutting Swing:	72" (182.88 cm)		
Number of Teeth on	48	Razor Wheel	
Cutter Wheel:	32	Standard Wheel	
Cutter Wheel Diameter	28" (71.12 cm)		
with Teeth:			
Fuel Tank Capacity:	19	Gallons (71.9 Liters)	
Hydraulic Tank Capacity:	16	Gallons (60.6 Liters)	

*Approximate weights depending on engine and optional equipment.

**Width is based on retracted track configuration.

Before operating the stump cutter, read this manual, the engine manual, and all the safety decals on the machine. Know all parts of the machine and their functions, especially the shut down procedures in case of emergency. No inexperienced person may operate machine. Inexperience may cause injury.

SAFETY FIRST ALWAYS!

This is the **Safety-Alert Symbol**. This symbol is placed on the machine and in the manual to alert the operator to the potential for bodily injury or death. The operator should pay close attention to the instructions whenever they see this symbol.



The **Safety-Alert Symbol** will be accompanied by one of the following words:
DANGER, WARNING, or CAUTION

- A **DANGER** symbol means that if the instructions are not followed the possibility of serious personal injury or death is probable.
- A **WARNING** symbol means that if the instructions are not followed there is a possibility of serious personal injury or death.
- A **CAUTION** symbol means there is an unsafe condition or practice that may cause personal injury or property damage.

PERSONAL PROTECTION:

- ❖ Wear face shield and hearing protection
- ❖ Do not wear loose-fitting clothing
- ❖ Tie back long hair
- ❖ Do not wear jewelry
- ❖ Keep clear of cutter wheel
- ❖ Keep away from moving parts
- ❖ Only operate in a well-ventilated area because of carbon monoxide

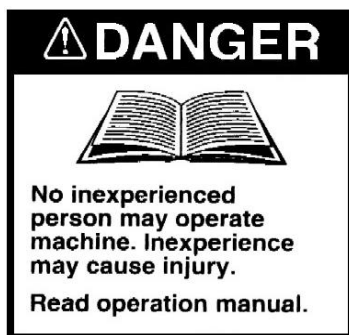
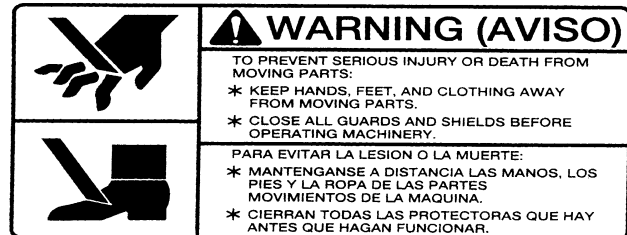

P/N 0700008



P/N 0700010



P/N 0700027



Be Safe and Practice Safe Operation using the following guidelines.



- Any individual operating this machine must first read and understand this manual, the engine manual, all component manuals, and all safety decals on machine.
- DO NOT permit children to operate machinery or to play near machinery during operation.
- Always wear face shield and hearing protection during operation. Loud noise and flying debris may cause severe injury.
- Keep hands, feet, legs, clothing, hair and all other body parts away from cutter wheel and other moving machine parts to eliminate the possibility of injury.
- Shut down machine completely and remove key before removing debris from work area (i.e. clearing rocks, wood chips, etc.).
- DO NOT modify or change any part without written approval from J. P. Carlton Company.
- DO NOT ride, sit, stand, lay, or climb anywhere on this machine during operation, while running, or during transport.
- DO NOT move, position, or transport this machine while cutter wheel is engaged.
- DO NOT operate any machinery while under the influence of alcohol or drugs (prescription, over the counter, or otherwise).
- DO NOT refill fuel tank while engine is hot, running, or indoors. Danger of fire or explosion exists.
- Fuel and its vapors are highly flammable and explosive. **Handle with care.** Only use approved fuel containers for storage.
- DO NOT store fuel containers near any open flames, sparks, or other sources of ignition.
- DO NOT store equipment with fuel in the tank.
- Battery fumes are explosive. Recharge battery in an open area away from fire, sparks, or other sources of ignition.
- Battery acid can cause severe burns. Keep away from eyes, skin, and clothing.
- Always remove battery before welding on equipment.
- Never check for hydraulic leaks using hand or finger, use cardboard or wood. Keep away from pressurized leaks. Pressurized fluid can penetrate the skin and cause injury or even death. Seek immediate medical attention if penetration occurs. Always wear eye protection.



 **WARNING**



 **WARNING**

 **CAUTION**

- **DO NOT OPERATE THE ENGINE AT AN ANGLE GREATER THAN 25° OR SEVERE ENGINE DAMAGE WILL OCCUR.** PROPER ENGINE OIL LEVEL MUST BE MAINTAINED TO ACHIEVE MAXIMUM ANGLE OF OPERATION OF 25°. (See Engine Owner's Manual for proper oil level.)
- Never allow spectators to stand and watch machine in operation without proper hearing and eye protection and standing at a safe distance. Loud noise and flying debris may cause severe injury.
- **DO NOT** operate around water, gas, power or phone lines. Check with property owner or call utilities if not sure.
- Avoid fences and clear away other objects (i.e. sticks, stones, metal, etc.).
- Be aware of the possibility of foreign objects imbedded in or buried around the stump. Do not cut crosswise of roots above ground to prevent roots being thrown.
- If unusual vibration occurs, stop engine immediately and correct problem before continuing operation.
- Keep all guards in place and properly secured during operation.
- Keep all safety devices working properly and all other machine parts in good working condition.
- Never leave the controls unattended while in operation. Be sure machine is not capable of operation when left unattended.
- Stop engine and remove key when repairing or adjusting machine or drive belts.
- Keep engine in good condition, service as instructed in engine manual.
- **DO NOT** touch engine while running or hot (serious burns may result).
- Allow all machine parts to cool completely before servicing or adjusting. Hot machine parts can cause severe burns.
- **DO NOT** run the machine without a complete number of teeth in the cutter wheel tightened to the correct torque.
- **DO NOT** place machine in free wheel without first placing tongue stake in the ground.
- Park machine on level surfaces only. Lower cutter head to the ground and use wheel chocks to prevent unattended movement.
- **DO NOT** operate stump cutter in dark, dim lit, or concealed areas.
- Keep machine clean and clear of debris to eliminate fire hazard. It is especially important to clean any oil or fuel spills to prevent the danger of fire.
- Keep cutter wheel skirt guards in good condition to help control chips during grinding.
- Keep safety and instructional decals clean and replace any that are damaged, difficult to read, or missing. Decals may be purchased from J.P. Carlton or an authorized dealer.



⚠ DANGER

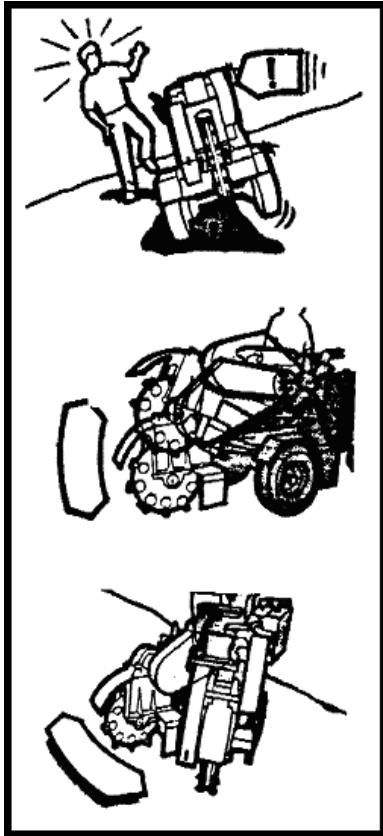

- This machine can tip over sideways if operated on non-level surface. This can cause serious injury to operator and machine.
- Avoid steep side inclines when operating this machine! The narrow design width required for operating this model machine in tight confines, makes it susceptible to tipping over sideways. Overturning this machine can result in personal injury, property damage and/or seizing the engine.
- While in transit, positioning the cutter wheel **uphill** and as close to the ground as possible, will minimize the danger of tipping over and maximize the steadiness of the machine.
- When encountering a hill, the best approach is straight up or straight down. Avoid any side angles whenever possible. **NEVER ALLOW INEXPERIENCED PERSONS TO OPERATE THIS MACHINE!**

DAILY CHECKS SHOULD BE PERFORMED BEFORE STARTING ENGINE FOR THE DAY. **DO NOT** INSERT KEY INTO ENGINE UNTIL ALL CHECKS HAVE BEEN COMPLETED.

- Check engine oil at dipstick. **Engine must be level.** Boom in raised position will not affect the engine position; machine must be on level ground. Add recommended oil, as required. (See **Engine Owner's Manual**)
- Inspect dry air filters. **REPLACE, if necessary, WITH FACTORY AIR FILTER ONLY.** Do not blow out or tap on ground. Replace inner safety filter when dirty or when the outer air filter has been changed 3 times. Do not blow out the inner safety filter or tap on ground. (See Engine Assembly section for part numbers.)
- Check fuel filter for debris or water. Replenish fuel tank with fresh fuel.
- Check condition and tightness of drive belts. (See Maintenance Section) New belts will stretch and become loose as machine runs. Check belt tension often when belts are new.
- Check for any loose, broken, or missing teeth and pockets.
- Inspect bolts, hydraulic fittings, wiring harnesses, hoses, and equipment for tightness, wear, or leakage. Replace if necessary.
- Check hydraulic oil level. A sight glass is located on the tank. Add oil if required. In hot weather do not fill window full, the oil will expand and spill out.
- Grease boom and jackshaft bearings daily; apply only 2 to 4 shots of grease. Do not over grease.
- Cutter wheel bearings must be purged with grease daily. Purge until clean grease is seen.

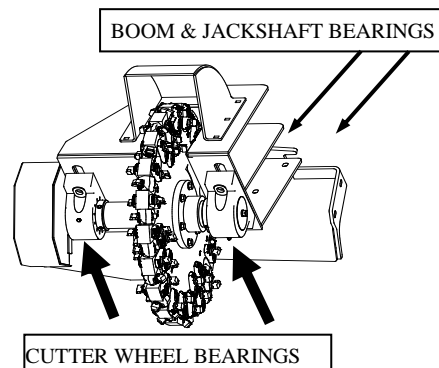
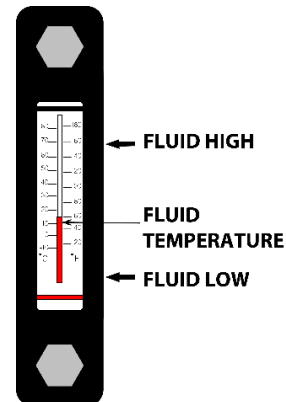
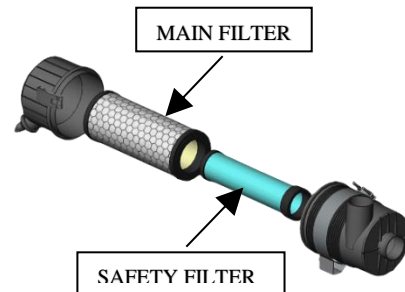
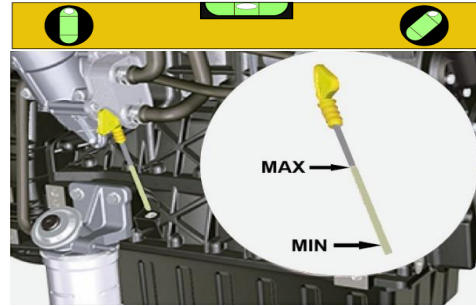

HYDRAULIC CONTROLS

Your track or wheel machine has a series of hydraulic controls located on the machine control panel and radio transmitter, which are clearly marked for use. To operate, push toggle switches in the direction of the command you want to perform. See illustrations (right) and details below.



TRACK MACHINE:

- **BLADE / TRACK WIDTH**
(Located on Machine Only) This is a dual function switch to control the track width or blade Up/Down operations. Set the switch to the desired function then use the TRACK WIDTH(OUT/IN) switch (see details below) to operate machine.
 - **RIGHT TRACK (FWD/REV)**
(Shown as R. TRACK-FORWARD / REVERSE on Remote.) This switch operates only the right track drive motor.
 - **LEFT TRACK (FWD/REV)**
(Shown as L. TRACK-FORWARD / REVERSE on Remote.) This switch operates only the left track drive motor.
- Use both controls in the same direction (FWD/FWD or REV/REV) to move machine forward or reverse. The radio transmitter also has a single switch (**BOTH TRACKS**) that will move both tracks at the same time in the forward or reverse directions.
- Use controls opposite (REV/FWD or FWD/REV) of each other to turn machine either right or left. When rotating the machine, try not to leave one track stationary while rotating the other one around as this could cause the machine to jump a track. If it is desired to spin the machine, counter-rotate the tracks.

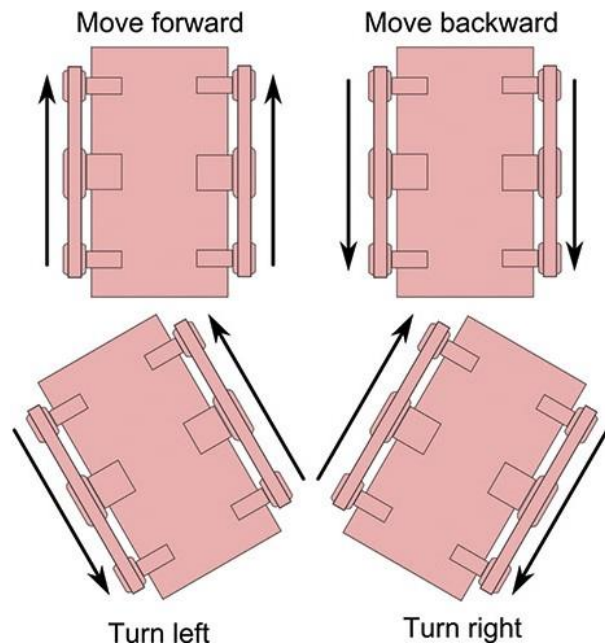

HYDRAULIC CONTROLS -TRACK (cont.)

- TRACK WIDTH (OUT/IN)**
(Shown as TRACKS-IN/OUT on Remote.)
This switch controls two functions, Track Width or Blade (Up/Down). Use this switch to **extend** the track width for more stability in positioning and during grinding or to **retract** the track width for maneuvering the machine through tight places. When set for Blade function, use this switch to raise and lower the blade. **Note:** the **Blade/Track Width** switch on the machine determines the active function.

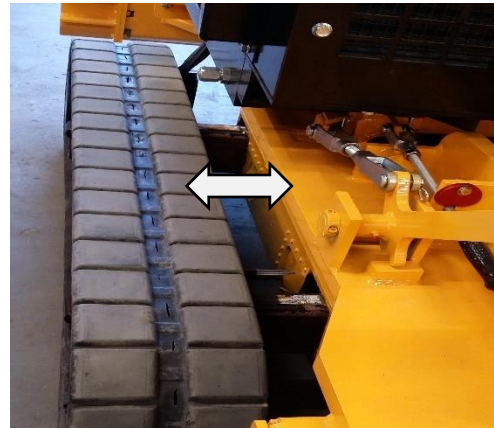

- CUTTER WHEEL (DOWN/UP)**
(Shown as CUTTER HEAD-DOWN/UP on Remote.)
This switch operates the cutter head lift function, which lowers and raises the cutter head.



- SWING ROTATION (LEFT/RIGHT)**
(Shown as CUTTER HEAD-LEFT/RIGHT on Remote.)
This switch operates the cutter head swing function, which swings the boom back and forth in a left-right-left-right-left... motion.

- SWING SPEED ADJUSTMENT VALVE**
Located on the side of the control panel unit, this valve controls the swing speed of the cutter head. Adjust swing speed for smooth operation. Turn the valve control knob counter-clockwise to slow the swing speed at high engine speeds. Close the valve by turning clockwise to allow the cutter wheel to move side to side at low engine speed.

- GROUND SPEED ADJUSTMENT VALVE**
Located on the side of the control panel, this valve controls ground (travel) speed when in low flow mode. Turn the valve clockwise to increase speed and counter-clockwise to slow speed.



HYDRAULIC CONTROLS -TRACK (cont.)

- FLOW (HIGH/ LOW)** (Same on Remote)
Flow control affects how fast the machine travels. High flow is for moving the machine from one place to another very quickly. Low flow is used for more precision in tight places or when positioning the cutter wheel close to the stump. For further control of the ground speed in low flow, use the Ground Speed Adjustment Valve. **(Note: The machine must be in low flow before operating the cutter wheel. Also, to control the flow selection functionality with the wireless remote, the flow switch on the machine control panel must be in the LOW position.)**

To operate using the radio transmitter, toggle the Gear/Flow switch down once for HIGH Flow and down a second time for LOW Flow.

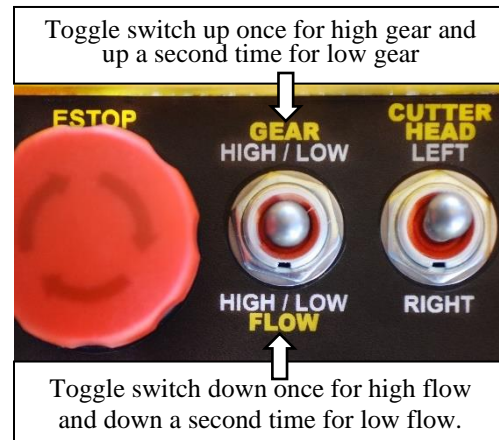

- GEAR (HIGH/ LOW)** (Same on Remote)
Gear control affects both the travel speed and track motor torque. In high gear the machine moves faster with less track motor torque. In low gear the machine will travel slower with more track motor torque. Use low gear in situations where more climbing power and track motor torque are needed. To operate from the radio transmitter, toggle the Gear/Flow switch up once for HIGH Gear and up a second time to go to LOW Gear. **(Note: to control the gear selection functionality with the wireless remote, the gear switch on the machine control panel must be in the LOW position. Also, when the transmitter is shut down (E-Stop), the Gear/Flow switch reverts to low.)**

GEAR / FLOW COMBINATIONS		GEAR	
		LOW	HIGH
FLOW	LOW	Slowest Speed / High Torque	Medium Speed / Low Torque
	HIGH	Medium Speed / High Torque	Fastest Speed / Low Torque

Use Ground Speed Adjustment control to fine tune travel speed in low flow mode.

HYDRAULIC CONTROLS (cont.)

WHEEL MACHINE:

- STEERING TRAVEL (RIGHT / LEFT)**
(Shown as STEER on Remote.) This switch operates the front tires directing them right or left.
- UNIT TRAVEL (FWD / REV)**
(Shown as TRAVEL on Remote.) When in 2WD, this switch operates the dual drive motor on rear wheels. In 4WD, it operates the rear and front drive motors for maximum traction. Refer to 4WD/2WD control details.
- CUTTER WHEEL (DOWN / UP)**
(Shown as CUTTER HEAD-DOWN/UP on Remote.) This switch controls two functions, Cutter Wheel or Blade (Up/Down). Use this switch to raise and lower the cutter wheel or the Blade. (**Note: The Blade/Lift switch on the machine determines the active function. Refer to Blade/Lift control for more details.**)
- SWING (LEFT/ RIGHT)**
(Shown as CUTTER HEAD-LEFT/RIGHT on Remote.) This switch operates the cutter head swing function, which swings the boom back and forth in a left-right-left-right-left... motion.
- FLOW (HI / LO)**
(Same on Remote) The switch controls the drive motors and determines how fast the machine travels. High flow is for moving the machine from one place to another very quickly. (**Note: the cutter wheel will not operate in High Flow.**) Low flow is used for precision when positioning the cutter wheel close to the stump or when more power is needed for climbing. For further control of the ground speed when in low flow, use the ground speed adjustment valve. (**Note: to control the flow selection with the remote, the flow switch on the machine control panel must be in the Low position.**)

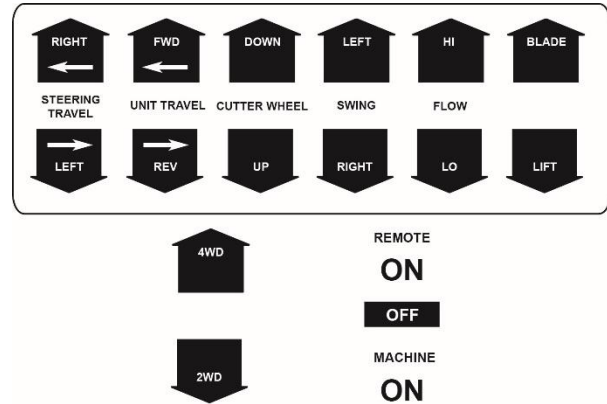

HYDRAULIC CONTROLS -WHEEL (cont.)

- BLADE / LIFT**
(Located on Machine Only) This is a dual function switch to control the Cutter Wheel Down/Up or Blade Down/Up operations. Set the switch to the desired function then use the Cutter Wheel (DOWN/UP) switch to operate machine.
- 4WD / 2WD** (Same on Remote) This switch determines if the machine is driven by the rear wheels (2WD) or by the rear and front wheels (4WD). (**Note: to switch between 2WD and 4WD with the remote, the switch on the machine control panel must be in the 2WD position.**)
- LIFT SPEED ADJUSTMENT VALVE**
Located on the front of the machine, the lift speed adjustment controls the down speed of the cutter wheel to prevent the cutter head from dropping to fast. Turn the control knob counter-clockwise to slow cutter head down speed or turn the control knob clockwise to increase down speed.
- SWING SPEED ADJUSTMENT VALVE**
Located on the side of the control panel unit, this valve controls the swing speed of the cutter head. Adjust swing speed for smooth operation. Turn the valve control knob counter-clockwise to slow the swing speed at high engine speeds. Close the valve by turning clockwise to allow the cutter wheel to move side to side at low engine speed.
- GROUND SPEED ADJUSTMENT VALVE**
Located on the side of the control panel, this valve controls ground (travel) speed when in low flow mode. Turn the valve clockwise to increase speed and counter-clockwise to slow speed.

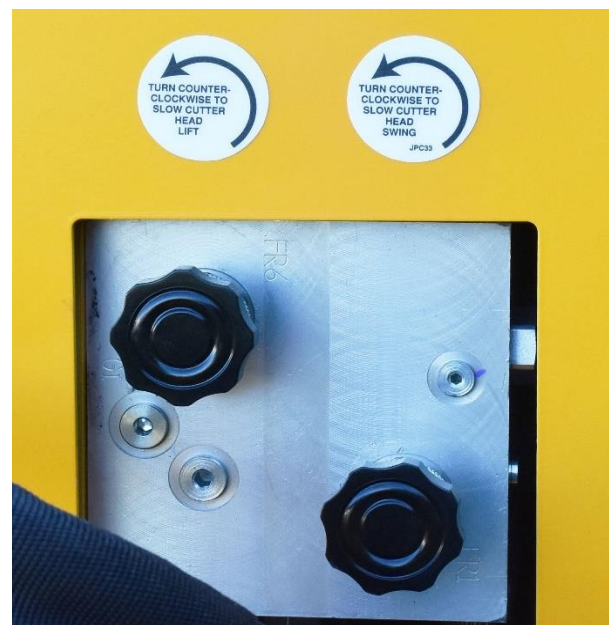

CUTTER WHEEL ENGAGEMENT LEVER

⚠ DANGER

Engaging or Disengaging Cutter Wheel at High Engine Speed Can Cause Personal Injury and Machine Damage. **Always Disengage Before Turning Machine On/Off.**

- **Before engaging or disengaging the cutter wheel, make sure the engine is at an idle speed!** To engage the cutter wheel, lift the slide lock lever and pull the engagement handle towards the engine. To disengage the cutter wheel, push the handle away from the engine.

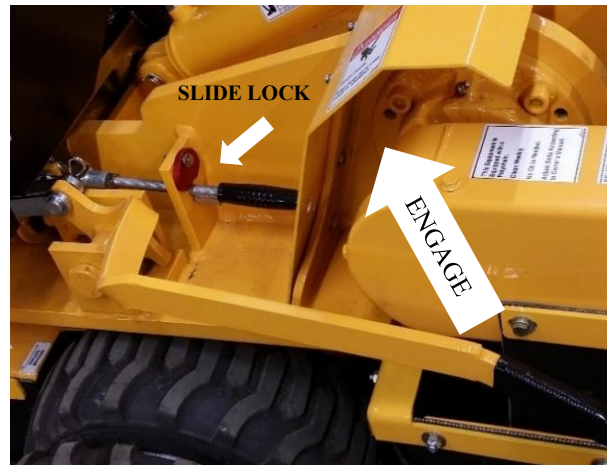

ENGINE CONTROLS

*Refer to the engine manufacturer's manual for controls, operation, and service.

This machine is equipped with an On/Off toggle switch and engine ignition key switch for startup and shutdown of the engine. The On/Off toggle switch must be switched to the On position before engine will start.

- **On/Off Switch**

This is a three-position switch; Off, Remote On or Machine On. To operate the machine with the remote control, first place the switch in the Remote On position then turn the engine ignition key switch to the On position. Follow the Remote Operations procedure to complete startup. To operate using machine control panel, first place the switch in the Machine On position then turn the engine ignition key switch to the on position. To shut off the engine, return the On/Off switch to the Off position. (Refer to Machine Operations Section of manual for startup and shutdown procedures)



ENGINE CONTROLS (cont.)

- **Ignition Switch**

Turn the ignition key switch clockwise one stop (On position) to turn the electrical system on. The key should remain in the on position while the engine is running. Turn the key fully clockwise (Start position) this will start the engine. To shut off the engine, return the key to the off position. (Refer to the engine manufacturer's manual for specific engine controls and operation.)



REMOTE CONTROLS

* Refer to the remote manufacturer's manual for specific controls, operation, and service.

- **Emergency Stop Button (E-STOP)**

Press button then toggle any switch on the remote to activate transmitter. Within 10 seconds, twist E-Stop button clockwise and release to turn on the transmitter for use. To turn off the transmitter and immediately shut off the engine, Press E-Stop button.

- **Toggle Switches**

Push toggle switches in the direction of the command you want to perform. See previous section under Hydraulic Controls for details on function of each switch.

- **Low Battery/Fault Light**

Light will indicate when battery is low or if a fault exists. (Refer to manufacturer manual for troubleshooting)

- **Active Light**

Light will flash on power up and during normal operation.

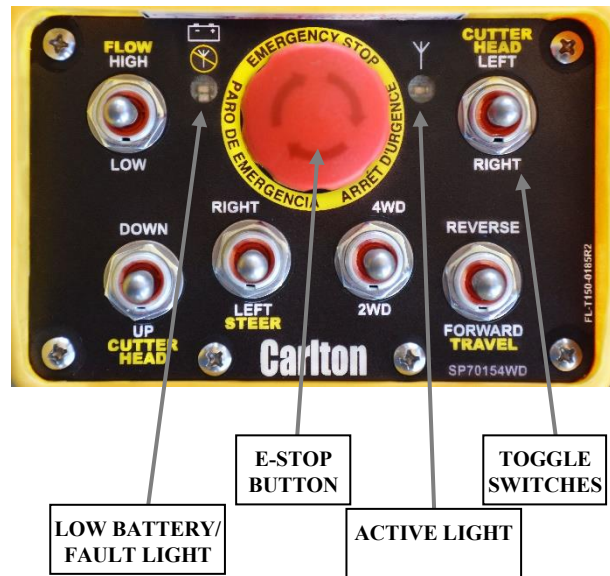

PROGRAMMING WIRELESS REMOTE

If there is a problem with the receiver or the transmitter and either must be replaced, you will need to program the new unit to communicate with the existing unit. Or if you have more than one transmitter for this machine, it will need to be programmed to communicate with the existing receiver. (Refer to the provided radio control manual for detailed programming instructions.)

- To access the receiver, remove the cover from the machine control box.
- Remove the radio receiver unit by removing the screws in the junction box lid. Then remove the circuit panel by unlatching the plastic tabs on either side of the receiver housing. The receiver panel will now slide out of the cap. **Note:** you may need to unplug the wiring harness before removing the circuit panel. Be sure to plug harness back in before attempting to program remote.
- Follow the instructions in the radio control manual to download the ID Code.
- Push the receiver panel back up into the cap until the tabs snap back into place.
- Replace junction box lid and tighten screws.
- Replace the machine control box cover.



CAUTION

Do Not Run Machine Without All Guards and Covers in Place and Secure.

Do Not Weld on the Machine Without First Disconnecting the Battery and Wireless Receiver Wire Harness.

**CAUTION**

DO NOT TOW! This machine is designed to be transported to the job site and will move under its own power once on site. Transport machine in a suitable vehicle designed for a load of these dimensions and weight. A low trailer is recommended due to its decreased entry height and will be safer all around.

- **LOADING RAMPS MUST BE STURDY AND ATTACHED TO THE TRANSPORT VEHICLE BEFORE ATTEMPTING TO LOAD/UNLOAD THIS MACHINE.**
- **TRAILER MUST BE SECURELY ATTACHED TO TOW VEHICLE BEFORE LOADING OR UNLOADING THE STUMP GRINDER.**
- Check trailer for security and make sure chains are properly installed.
- Check tire inflation.
- Check towing lights for proper operation
- Never transport with motor running.
- Towing will affect handling. Allow for extra stopping distances.
- Start and stop gradually.
- Tow at a safe reasonable speed.

⚠ WARNING

Trailer must be securely attached to tow vehicle before loading or unloading the stump grinder.
Do not unload on anything other than level ground!

LOADING

- Start engine as recommended by the engine manufacturers manual.
- Increase engine RPM, raise cutter head just off the ground.
- With operator in position, push the forward travel control lever and steer machine slowly up appropriate ramp into transport vehicle.

KEEP MACHINE AS LEVEL AS POSSIBLE.

- Continually adjust cutter head height as you go, keeping the mass as low to the ground as possible.
- Once the machine is loaded, lower the cutter head, shut down engine and secure machine tightly with sufficient tie downs to prevent any movement in transit.

**UNLOADING**

- Undo tie down straps and check ramps for sturdiness and positioning.
- Start engine, increase RPM, and raise cutter head to just clear deck and/or ramp.
- Continually adjust Cutter head up and down to keep the center of gravity as low as possible.
- Proceed to work site using extreme caution on hills or uneven terrain.



STARTING

***Read this Manual, All Machine Decals, and the Engine Manual Before Starting.**

- Check all fluids before starting.
- Drive belts (cutter wheel) must be disengaged before starting.
- Inspect all connections, teeth, tires, etc. (See Daily Checklist).

CAUTION

Do Not operate the engine at an angle greater than 25° or severe engine damage will occur. Proper engine oil level must be maintained to achieve maximum angle of operation of 25°. Refer to the engine manufacturer's manual for proper oil level.

Do Not operate around water, gas, power, or phone lines. If in doubt, check before grinding. Avoid traversing slopes. Ascend/descend hills straight up & down

Wear face shield and hearing protection.

Keep clear of cutting wheel and moving machine parts.

Keep spectators away.

The SP7015 stump grinder is a radio control machine. To start the engine and the radio control transmitter, follow these instructions.

- Turn the control panel On/Off switch to the **Remote On** position and the engine ignition key switch to the ON position. (Note: To use the machine without a remote, set the On/Off switch to the Machine On position and follow Start Engine process.)
- On the transmitter, press the **E-STOP** button down.
- Toggle any switch on the transmitter.
- Twist the **E-STOP** button clockwise to release. (Note: Release the E-STOP button within 10 seconds to power up the transmitter or the unit will power down.) When the transmitter is operating there is a yellow ACTIVE light that will be flashing, the light is indicated in the picture at the right. (Read the radio control manual for more information on the meaning of different lights and colors.) If the transmitter does not start, check the transmitter for stuck switches; it will not start with a switch in the ON position.

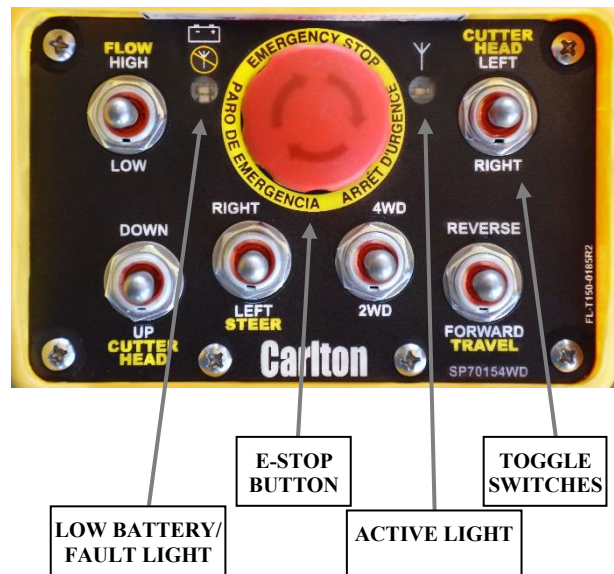
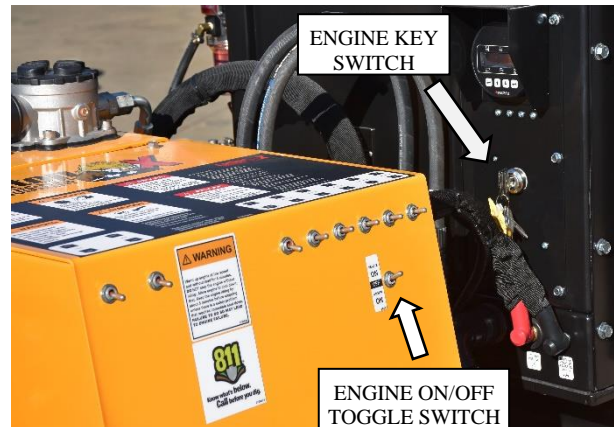

- Start engine. Turn the ignition key switch clockwise one stop (On position) to turn the electrical system on. The key should remain in the on position while the engine is running. Turn the key fully clockwise (Start position) this will start the engine. To shut off the engine, return the key to the off position. (Refer to the engine manufacturer's manual for specific engine controls and operation.) If the engine doesn't start right away and you have to restart it, turn the key switch OFF and back ON. Make sure the light on the transmitter is still on and restart the engine by turning the key. If you lose the connection (light off), repeat the procedure from the beginning and perform each step exactly as described.

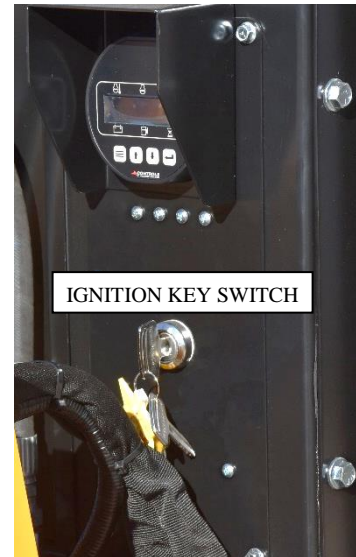

- Start engine at half speed and allow enough time for oil to circulate before proceeding.
- Set the remote Flow Switch to LOW. **Note:** Cutter head functions only operate in low flow. (Refer to Machine Controls section for more details on controls.)
- Test controls for proper operation.
- Position machine at stump with cutter wheel a slight distance away from the stump.



CAUTION

Do not engage cutter wheel when positioning machine near stump. Hitting the stump with the cutter wheel running will break the Poly Chain® belt.

- Reduce engine speed to idle. (Approximately 1000-1200 RPM)
- Raise cutter wheel clear of stump.



⚠ DANGER

Engaging or Disengaging Cutter Wheel at High Engine Speed Can Cause Personal Injury and Machine Damage.
Always Disengage Before Turning Machine On/Off.

- Engage cutter wheel by lifting the slide lock lever and pulling the engagement handle toward the engine slowly enough to prevent stalling the engine. (Refer to illustration)
- Bring the cutter wheel to speed by controlling the engagement handle to slowly engage the cutter wheel. If handle is engaged to quickly or at high engine speed, belt, sheave, and/or engine damage could occur.
- With the cutter wheel fully engaged, you can now move the engine throttle to the preferred engine operation position.
- Test controls for proper operation, speed, and unobstructed movement.
- Cutter head swing speed should be adjusted to a rate that will allow cutter wheel to pass through stump smoothly. If jerking, bouncing or significant drops in engine speed occur, swing rate is too rapid and must be decreased.
- Swing speed should be determined and adjusted with the controls in the full open position.
- A bypass flow control valve is located within the hydraulic system to adjust this speed. Turning the handle counter-clockwise will open the bypass and slow swing action. Turning it clockwise will increase swing rate.

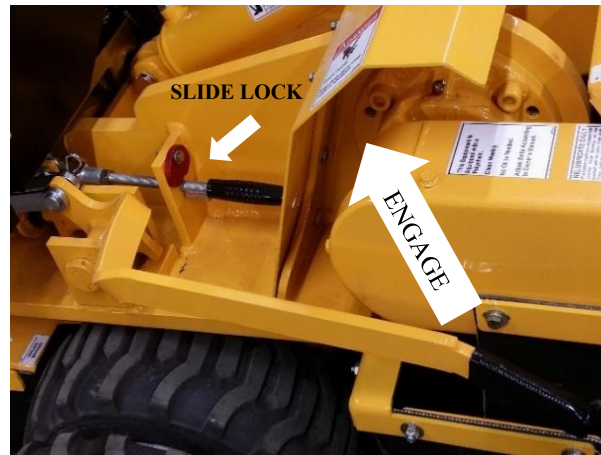

- Lower spinning cutter wheel to stump and make a few light passes at stump to get a feel for the cutting action.
- Gradually increase cutting action and work away at stump by swinging cutter wheel left- to-right-to-left through stump in a sideways motion. Smooth, effortless cutting extends machine life, minimizes downtime and is more profitable in the long run.
- Continue cutting stump by adjusting cutting wheel progressively lower until stump is cut well below ground level.
- Raise and swing cutter wheel clear of stump then position machine closer to the stump for next series of passes. Lower and continue cutting.
- Continue in this manner until stump has been removed.

CAUTION

For optimal performance, the stump should be cut with the portion of the cutter wheel shown. **Never undercut the stump.** Undercutting the stump can cause severe kickback, vibration, and component damage. **Never cut the stump from the top.** The cutter wheel will throw debris up and toward the operator, instead of down and under the machine.

- Larger stumps may require repositioning machine to work at best advantages.
- Raise cutter wheel clear of stump and return to center position.
- Reduce engine speed to idle. **DO NOT TURN OFF MOTOR.** Engine must be allowed to cool slowly at idle for 3-5 minutes to avoid damage.

⚠ DANGER

Engaging or Disengaging Cutter Wheel at High Engine Speed Can Cause Personal Injury and Machine Damage. **Always Disengage Before Turning Machine On/Off.**

- With engine at idle (Approx. 1000 rpm), disengage drive belts by slowly releasing engagement handle.
- Turn off motor. Allow cutter wheel to come to a complete stop before inspecting work area.

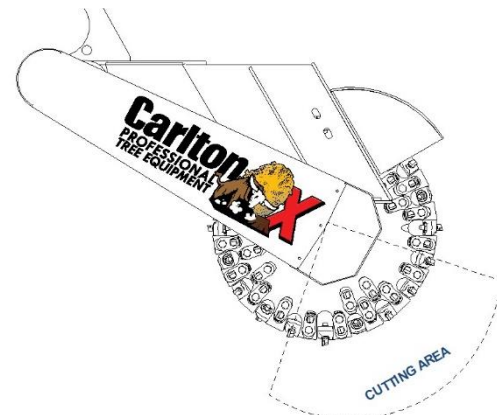

POSITIONING MACHINE

The SP7015 Wheel and Track machines have features that provide optimal stability during normal operation and positioning. For your safety and for the protection of your machine, follow these guidelines.

- The wheel machine comes equipped with dual rear wheels for stabilization when maneuvering around the work area and operating the boom when cutting. The dual wheel configuration allows for the outer wheels to be removed when required to access a narrow entryway or gate. Properly reattach the outer wheels before continuing with normal operations and cutting.
- The track machine comes equipped with expandable tracks. The expanded wide stance should be used when maneuvering around the work area and when operating the boom when cutting. The narrow track stance should only be used when accessing narrow entryways or gates.

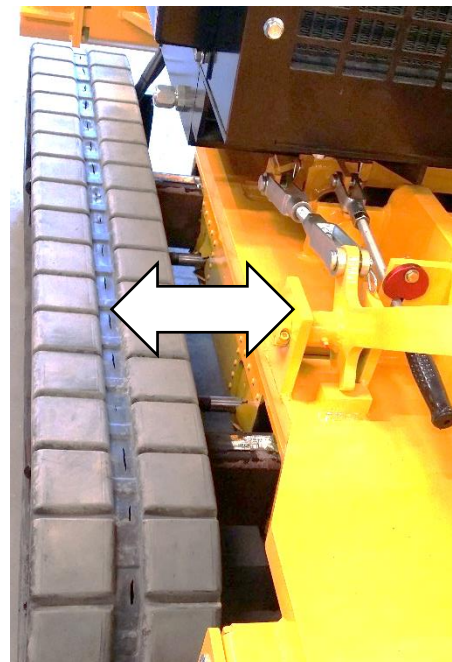

CAUTION

Never operate the boom and cutter wheel in a narrow stance position.

Ensure dual wheels are properly installed and/or tacks expanded before approaching the work area. This keeps you and your machine safe and provides for optimal performance.

⚠ DANGER

More accidents occur while performing maintenance than any other time! Use extra caution!!
DO NOT PERFORM MAINTENANCE OF ANY KIND ON THIS MACHINE UNLESS:

- ◆ The engine is turned off.
- ◆ The ignition key has been removed.
- ◆ The positive battery cable has been disconnected.
- ◆ The cutter wheel is disengaged.
- ◆ All machine parts have come to a complete stop.
- ◆ All machine parts have had sufficient time to cool down.
- ◆ No operator is in position at the controls to accidentally start machine.
- ◆ At least 2 people are at the site where maintenance is performed.

• **PLACE THE CUTTER WHEEL ON THE GROUND WHEN PERFORMING SERVICE ON A MACHINE.**

- Check engine oil at dipstick (**Daily**). Take reading with engine **sitting level**. Add recommended oil and change oil as required. (See engine owner's manual for details.)

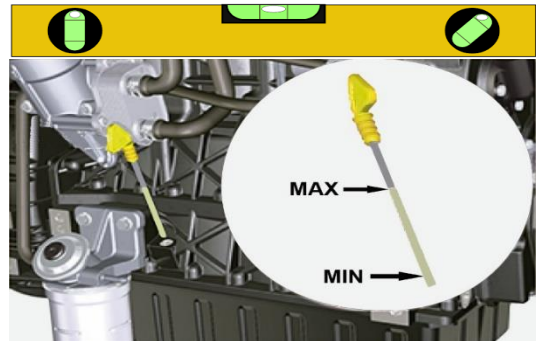

- Check hydraulic oil with engine off and cool (**Daily**). A site glass is provided for easy viewing. Oil should be visible in the site glass before operating. Replenish, as necessary. Do not fill the tank more than 3/4 the way up the site glass to allow space at the top for expansion as oil gets warm. Remember to replace and tighten cap. Note: This machine is filled with Citgo AW32 hydraulic oil at the time of manufacture. Refill with the same or equivalent oil.

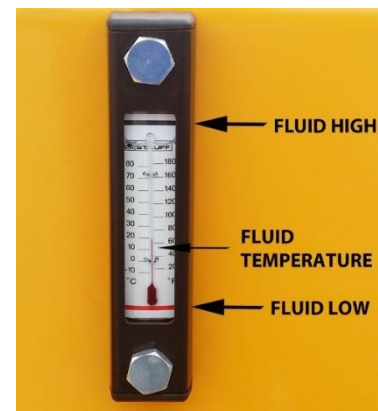

- Inspect hydraulic hoses and fittings for leaks, tightness, wear, or damage (**Daily**). Repair or replace as needed. (See hydraulic servicing section for details.)

⚠ WARNING

Hydraulic oil is under pressure. Spraying fluid from a leak can burn or penetrate the skin and cause serious injury. If fluid penetrates the skin, immediately seek medical attention to have it surgically removed! **Always wear eye protection!**



- Check cutter wheel, pockets, and teeth for wear (**Daily**). If any repair is needed, see Servicing Cutter Wheel section for further instructions. **DO NOT OPERATE STUMP CUTTER WITHOUT A COMPLETE SET OF TEETH.**



- Check setscrews in jackshaft bearings for tightness (**Weekly**). NOTE: to access the jackshaft bearings, you will need to remove the jackshaft cover.

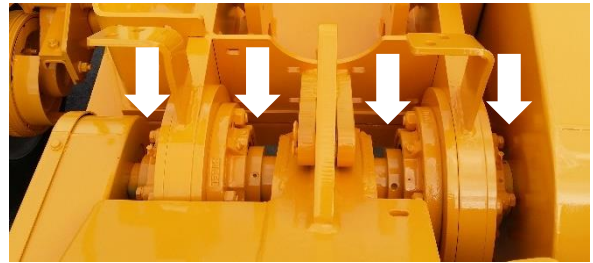

- Check setscrews in cutter wheel bearings for tightness (**Weekly**).

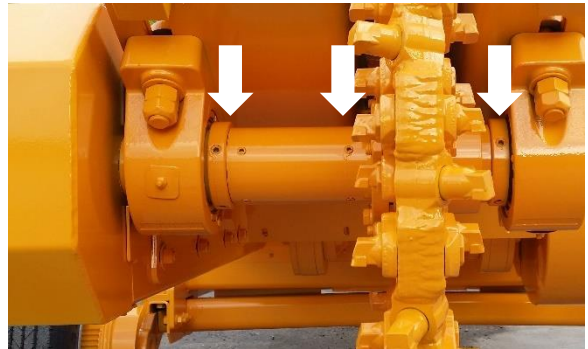

- Clean out Poly Chain® guard by removing bottom portion of guard (**Weekly**). **Woodchip buildup will wear or break Poly Chain® belt.**



BELTS

- Check belt tension (**Daily**). Inspect for wear and alignment (**Monthly**).
For details on replacing belts, see Servicing Belts section of this manual.

NOTICE

Tension on newly installed belts drops rapidly during the first hours of operation. Check and adjust frequently during the first 24 hours. **Do Not** over tighten belts. An overly tight belt can cause damage to the belt and bearings.

CHECKING BELT TENSION

- Remove belt guard cover.
Note: Belt should be in normal operating position.
- Use a metal bar or screwdriver as a measuring device to apply force to the belt. Place the device at the center of the belt span between sheaves. Use the belt guard housing as a straightedge or lay a straight edge across both sheaves. Without applying force, make a mark on the measuring device where it meets or intersects with the belt. Next, apply specified pounds of force to the belt and again mark the point where the measuring device meets the straightedge. Then measure the distance between the two marks on the measuring device and compare to the recommended deflection measurement. See illustration.
- If the measurement is more than recommended deflection, the belt tension is too loose. If the measurement is much less than recommended deflection, the belt tension is too tight. Follow procedure for Belt Tension Adjustment.

CHECKING SHEAVE ALIGNMENT

- Place a straightedge against the outside face across both sheaves. Check that both sheave surfaces are flush with the straightedge and aligned properly. See illustration.
- To align sheaves, follow procedure for Belt Tension Adjustments.

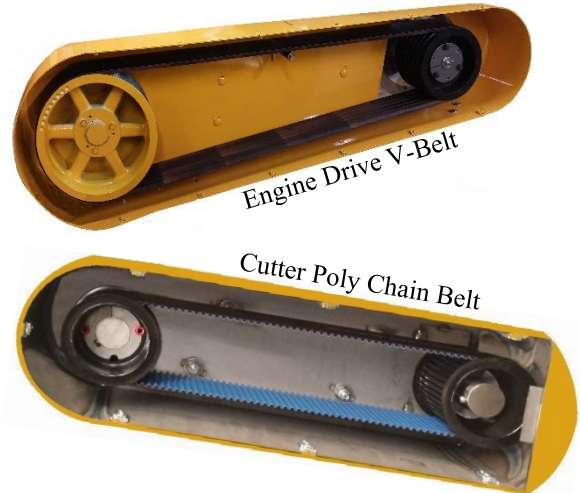

Main Drive Belt (V-belt): 1/2" (12.7 mm) deflection in with 25 lbs. (11.3 kg) of force.
Cutter Poly Chain Belt: 1/4" (6.35 mm) deflection in with 25 lbs. (11.3 kg) of force.

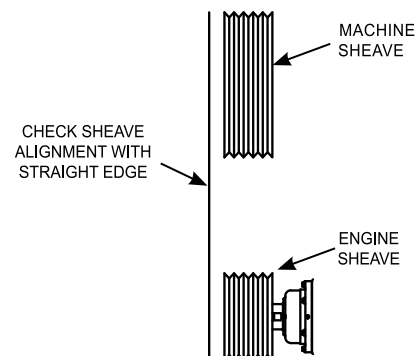
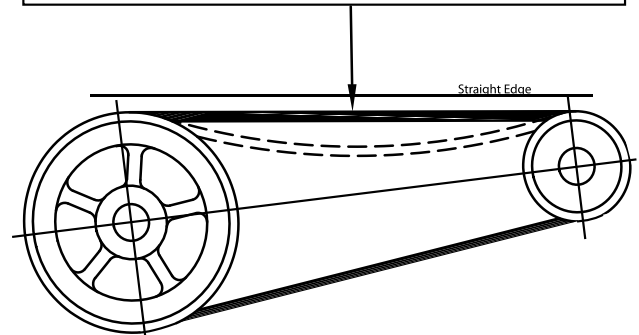

CHECK FOR WEAR

- Inspect belts, sheaves and/or sprockets for wear. See illustrations to assist with inspection. For details on replacing belts, see Servicing Belts section of this manual.

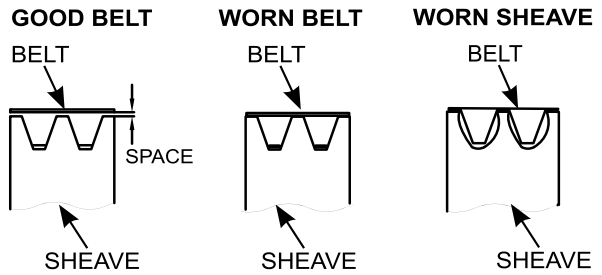

- V-Belt-drive efficiency depends on full contact between the belt and the sheave walls. As a sheave wears, the walls where the belt should ride go from being flat to being “dished” or concave. Therefore, worn sheaves dramatically reduce the efficiency of the drive.
VISUAL CUES. The worst sheave wear will be a highly-polished track in the sheave wall, deep enough that you can feel it with your finger. Lesser (but no less important) wear may be harder to spot with just your eyes. A sheave gauge, usually consisting of plastic wedges shaped like a new belt, can be inserted into the groove. If the gauge doesn't fit squarely into the groove and you can see daylight around the edges, your sheave is worn and must be replaced.

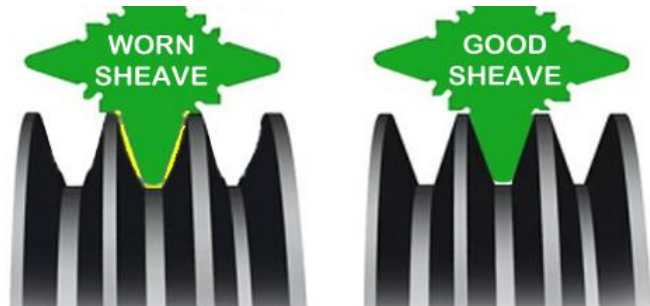

The sheave should be replaced when more than 1/32-inch gap is visible past the appropriate gauge or straight edge.

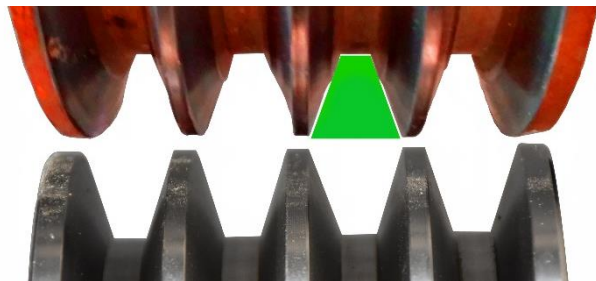

- Inspect sprocket grooves for unusual or excessive wear. Check for excessive wear by both visually inspecting the grooves and by running your finger along the sprocket grooves. If you can feel or see noticeable wear, the sprockets are worn and should be replaced.

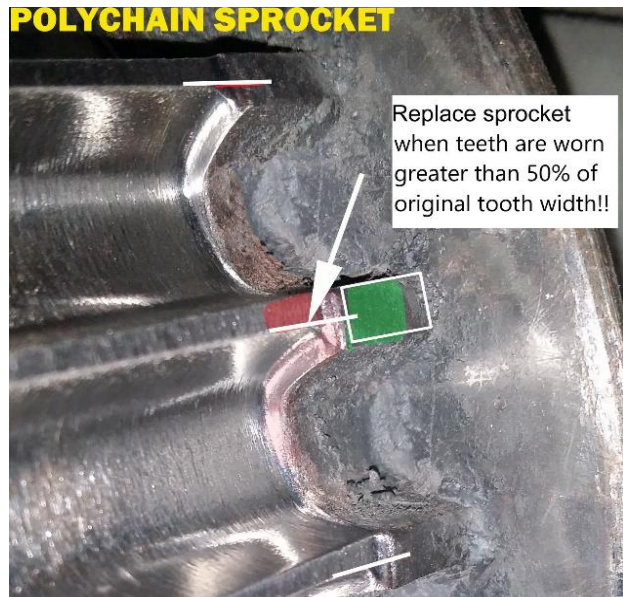

⚠ WARNING
Severely worn surfaces on sheave or sprocket faces may become very sharp. Wear gloves for protection from nicks or sharp surfaces.

BELT TENSION ADJUSTMENT

NOTICE

Inspect and/or repair the following before continuing with setting belt tension:

- Grease and oil on the belt: Grease and oil on a belt will cause rapid deterioration. Clean oil and grease from the sheaves, wipe the belt with a clean cloth.
- Burrs and rust in the sheave grooves: Remove burrs and rust.
- Wear, damage and misalignment of the sheaves and sprockets. Replace if excessively worn, frayed or soft.
- Belt clearance and shaft misalignment: Adjust belt guard and shaft.

Procedure for Engine Drive V-Belt:

- There is a linkage assembly below the engagement lever on the operator side. With the lever in the disengaged position, remove the yoke pin and adjust the yoke in or out as necessary to set the proper belt tension.
- To tighten belt tension, adjust the yoke out (counterclockwise).
- To loosen belt tension, adjust the yoke in (clockwise).
- Replace yoke pin and move the lever to the engaged position.
- Recheck belt tension. Repeat until proper tension is achieved.
- Adjust slide lock lever as needed to ensure it locks properly when engagement handle is in the disengaged position.
- Check sheave alignment with a straightedge.



LINKAGE ASSEMBLY ATTACHED TO ENGAGEMENT LEVER. REMOVE YOKE PIN AND ADJUST YOKE.

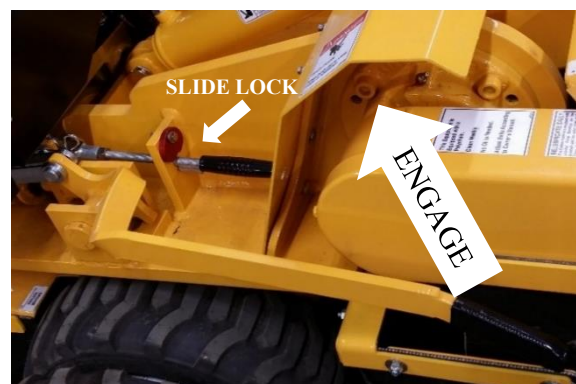

BELT TENSION ADJUSTMENT (cont.)

Procedure for Cutter Poly Chain Belt:

- There are two sets of jam bolts, a FRONT and REAR on each side of the cutter wheel. Each set has an outside and inside nut used to slide the cutter wheel bearing and shaft. **IMPORTANT!** Adjust both sides evenly to ensure proper sprocket alignment.
- To tighten belt tension, loosen the outside and inside jam nuts on both rear jam bolts. Then loosen both jam bolts to allow clearance for bearings to slide. Next, loosen the two bolts securing each cutter wheel bearing (both sides). Then, loosen the outside jam nut on both front jam bolts and slide the bearing shaft by tightening both jam bolts equally.
- To loosen belt tension, loosen the two bolts securing each cutter wheel bearing (both sides). Next, loosen the inside jam nut on both front jam bolts then loosen the bolts. Note: The bearing shaft should move due to belt tension but if necessary, tightening the rear jam bolt to slide the shaft.
- Make slight and equal adjustments at a time and recheck belt tension and sprocket alignment. Repeat until proper tension and alignment is achieved.
- When proper tension and alignment is achieved, tighten the cutter wheel bearing bolts and all loose jam nuts.

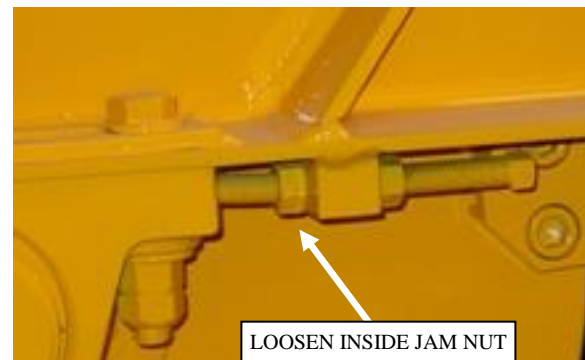
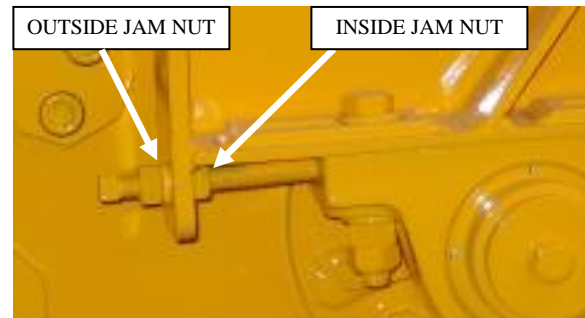
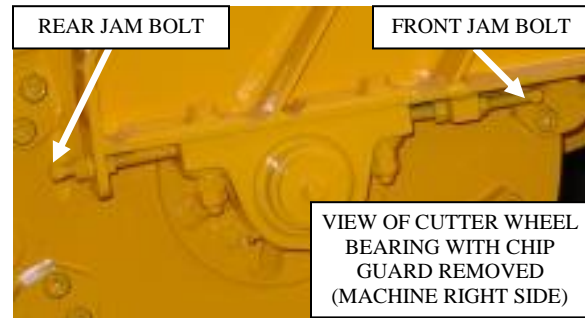

CAUTION

Never Operate Machine Without Belt Guard Covers in Place and Properly Secured. Check All Bolts for Tightness.

UNDERCARRIAGE

- Inspect wheels or tracks for signs of abnormal wear, damage, loose mounting bolts, tire air pressure or fluid leaks and proper track tension (**Daily**). It is recommended to fully expand tracks in/out on a (**Weekly**) basis to ensure they are working properly. **Note:** Debris can build up in track slides causing tracks not to expand properly. Regularly clean track frames with pressure washer to avoid build up.

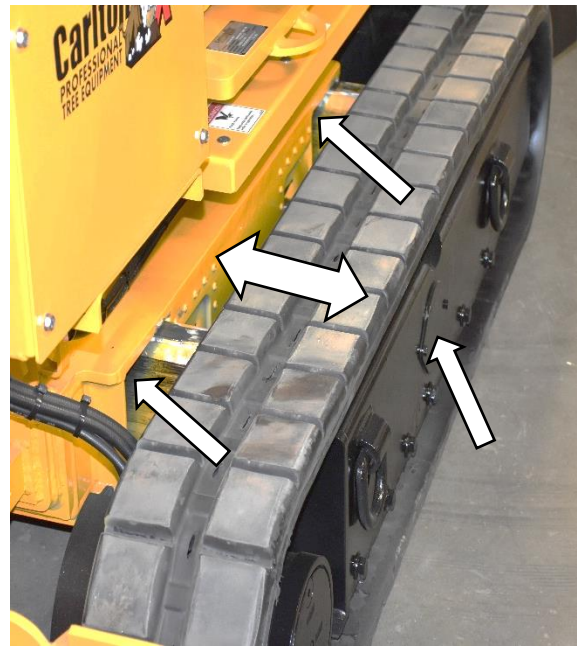

TRACK TENSIONING

- The tracks are tensioned by adding grease to the tensioning cylinder using a standard hand operated grease gun. Each track has a grease fitting located beneath a cover cap on the side of the track. (Refer to lubrication chart below.)

LUBRICATION CHART

- Use Starplex II grease or equivalent.
- Always clean tip of grease gun fitting and grease fitting on machine before attaching hose to prevent dirt from being forced into machine parts. **Note:** Wipe off excess grease. Excess grease will attract dirt.

Item No.	Item	QTY					Comments
			Daily	Weekly	2-3 Mo.	6 Mo.	
1	CUTTER WHEEL BEARINGS	2	•				Purge until clean grease is seen.
2	JACKSHAFT BEARINGS	2	•				2-4 Pumps with hand grease gun.
	BOOM BEARINGS	2	•				
3	ENGAGEMENT LEVER	1		•			1-2 Pumps with hand grease gun.
4	TURNTABLE BEARING	6			•		100 hour increments add 3-5 pumps with hand grease gun.
	ENGINE SLIDE FRAME	6			•		
5	STUB SHAFT BEARING	1				•	500 hour increments add 2-3 pumps with hand grease gun.
6	TRUNION CYLINDER (TRX HD)	2			•		1-2 Pumps with hand grease gun.
7	TRACK TENSION CYLINDER (TRX)	2	•				Check tension daily, lubricate as needed.
8	TRACK FINAL DRIVE (TRX)	2				•	Change after initial 200hrs. After that, every 1000 hrs. or annually, whichever comes first. Use SAE 30 CD OIL.
	ENGINE	*					*REFER TO MANUFACTURER'S MANUAL

LUBRICATION CHART (cont.)

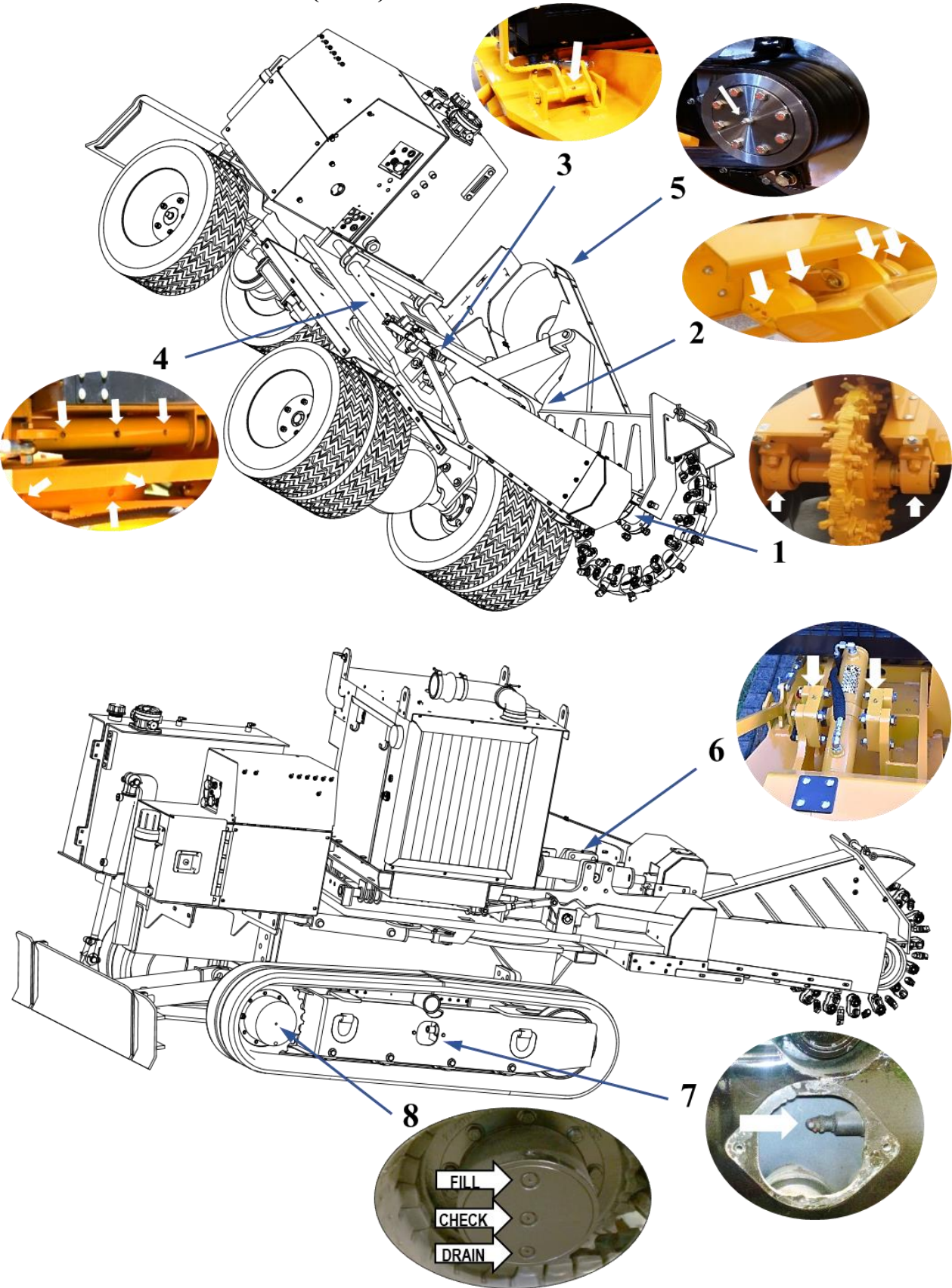

COMPLAINT	CAUSE	CORRECTION
Engine will not start. (See Engine Manufacturers' Manual for further information.)	<ul style="list-style-type: none"> • On/Off switch on machine control panel is in off position. • Loose ground wire. • Loose hot wire. • Dead battery. 	<ul style="list-style-type: none"> • Move switch to the ON position and follow normal startup procedure. • Clean and tighten. • Clean and tighten. • Recharge or replace.
Hydraulic system loss of power.	<ul style="list-style-type: none"> • Low oil. • Valve set too low. • Splined pump coupling worn. • Bad cylinder. • Bad Pump. 	<ul style="list-style-type: none"> • Refill with correct oil. • Adjust relief valve. • Remove pump coupler. • Replace cylinder packing. • Replace Pump.
Cutter Head Swing cylinder loss of power.	<ul style="list-style-type: none"> • Swing Speed adjustment valve turned wide open. 	<ul style="list-style-type: none"> • Turn valve clockwise to close bypass. Re-adjust for "no bounce" cutting.
Belt Squeal.	<ul style="list-style-type: none"> • Belt tension too loose. • Belt out of alignment. 	<ul style="list-style-type: none"> • Tighten. • Align Pulleys.
Belt jumping off.	<ul style="list-style-type: none"> • Engaging or disengaging belt at high engine RPM. • Belt keeper too far from belt. • Belt worn. • Pulley worn. 	<ul style="list-style-type: none"> • Only engage or disengage belts at low engine speeds. • Adjust keeper closer to belt. • Replace belt. • Replace pulley.
Cutter wheel vibration.	<ul style="list-style-type: none"> • Tooth missing. • Pocket out of balance. • Improper tooth arrangement. 	<ul style="list-style-type: none"> • Replace missing teeth. • Always replace pockets in pairs across from each other. • Install correctly with like pairs of teeth directly across from each other.
Standard Cutter wheel throwing teeth.	<ul style="list-style-type: none"> • Bad pocket. • Dirt in pocket. • Cutter wheel worn where tooth sits. 	<ul style="list-style-type: none"> • Replace pocket. • Clean pocket and replace missing teeth. • Replace cutter wheel.
Standard Cutter wheel breaking teeth.	<ul style="list-style-type: none"> • Teeth set too far out of pocket. 	<ul style="list-style-type: none"> • Use gauge to set teeth correctly.
Razor Cutter wheel throwing teeth.	<ul style="list-style-type: none"> • Bad pocket. • Tooth Nut not torqued properly. 	<ul style="list-style-type: none"> • Replace Pocket. • Tighten nut with torque wrench. (150 - 170 ft/lbs.)

COMPLAINT	CAUSE	CORRECTION
Cutter wheel stops turning.	<ul style="list-style-type: none"> • Belt not engaged. • Belt loose. • Engine belt broke. • Poly Chain® belt broken. • Sheared key in shaft. • Broke cutter wheel shaft. 	<ul style="list-style-type: none"> • Adjust yoke assembly. • Tighten belt. • Replace belt. • Replace belt. • Replace key. • Replace shaft.
Roar in machine when cutter wheel is engaged.	<ul style="list-style-type: none"> • Belt guard is out of place and rubbing on jack shaft or cutter wheel shaft. • Jackshaft or cutter wheel bearings going bad. 	<ul style="list-style-type: none"> • Re-position guard off shaft and tighten bolts. • Replace bearings.
Bearing will not take grease.	<ul style="list-style-type: none"> • Grease fitting clogged. 	<ul style="list-style-type: none"> • Replace fitting
Machine will not operate with remote.	<ul style="list-style-type: none"> • On/Off switch on control panel is not in the Remote On position. • On/Off switch is bad. 	<ul style="list-style-type: none"> • Shutdown machine and switch to the Remote On position, then restart. • Replace switch.
Traction loss of power.	<ul style="list-style-type: none"> • Hydraulic motor worn. • Hydraulic pump going bad. 	<ul style="list-style-type: none"> • Replace Hydraulic motor. • Replace Hydraulic pump. *Refer to dealer/service center.
Popping/clicking noise in rear end when moving wheel machine.	<ul style="list-style-type: none"> • Dual Wheel spacer not properly aligned with inner hub. • Loose dual wheel center bolt. • Tire pressure low on inner dual wheel. 	<ul style="list-style-type: none"> • Remove spacer, check hub bolts for tightness then align spacer to inner hub and tighten center bolt. • Tighten center bolt. • Check for air leaks. Repair/replace tire and add proper air pressure to inner wheel.
Track too loose.	<ul style="list-style-type: none"> • Tensioning cylinder too low on grease. 	<ul style="list-style-type: none"> • See Maintenance Section on Tensioning Tracks.
	<p>>WARNING: DO NOT OVER GREASE, TRACKS WILL BOW.</p>	
<p>NOTE: For all Radio Transmitter or Receiver Problems, refer to Manufacturer's Manual.</p>		

⚠ DANGER

More accidents occur while performing maintenance than any other time! Use extra caution!!
DO NOT PERFORM MAINTENANCE OF ANY KIND ON THIS MACHINE UNLESS:

- ◆ The engine is turned off.
- ◆ The ignition key has been removed.
- ◆ The positive battery cable has been disconnected.
- ◆ The cutter wheel is disengaged.
- ◆ All machine parts have come to a complete stop.
- ◆ All machine parts have had sufficient time to cool down.
- ◆ No operator is in position at the controls to accidentally start machine.
- ◆ At least 2 people are at the site where maintenance is performed.

- **PLACE THE CUTTER WHEEL ON THE GROUND WHEN PERFORMING SERVICE ON A MACHINE.**

CAUTION

Do not operate machine without a full set of teeth. Operating machine without a full set of teeth can cause excessive vibration and premature bearing failure.

- A standard cutter wheel on model SP7015 has a set of 32 total teeth. (2 straight, 15 left angled and 15 right angled)
- A locking pin is provided to hold cutter wheel in position during tooth removal and re-installation.
- Locking pin will only lock on outer teeth. **NEVER PLACE HAND ON CUTTER WHEEL TO HOLD IN PLACE WHILE CHANGING TEETH. BE SURE TO REMOVE PIN BEFORE OPERATING.**
- A Tooth Setting Gauge (P/N - 0450111) is provided with each machine for proper tooth installation. Line all teeth up with the inside edge of the groove in the gauge. Set **ALL** teeth to this edge with gauge against pocket, not against cutter wheel. All teeth are set 1 1/4" out of the pocket to the edge of the carbide.



TOOTH ARRANGEMENT

- Inspect pockets, teeth, and bolts for damage and replace as required.
- When replacing pockets, always replace new pockets across from each other in order to prevent vibration.
- Replacement teeth must be carbide tipped and have like design as provided with the machine.
- Use anti-seize on threads to prevent bolts from “freezing up” in cutter wheel pockets.
- When replacing complete set of teeth, be sure to duplicate original factory tooth arrangement.
- Torque bolts to 170 ft/lbs.

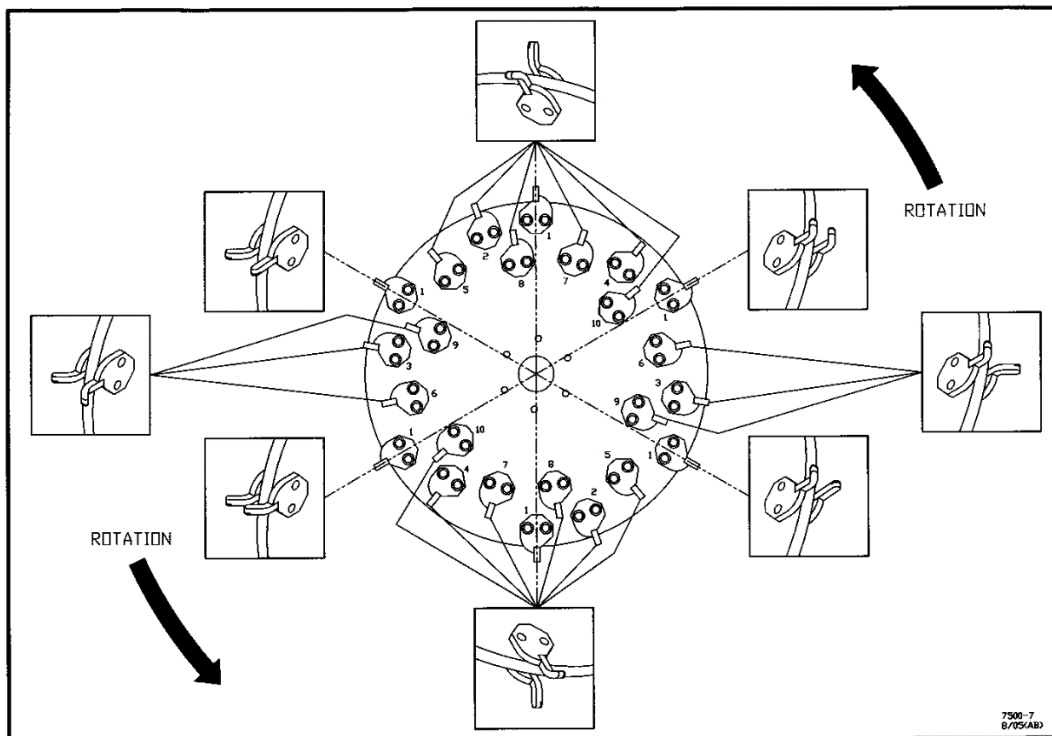

Opposing outside pockets carry like arrangements of teeth to cancel vibration

- Straight teeth are mounted in **TWO OPPOSING OUTSIDE POCKETS.**
- A straight tooth must have a 45° tooth accompanying it in the same pocket set. The opposite pocket set should have this same combination of straight and 45° teeth, except with positions reversed. Mounting these teeth opposite each other on the cutter wheel will cancel out damaging vibration.
- The **TWO OTHER OPPOSING OUTSIDE POCKETS**, as shown, must have 45° teeth overlapping centerline of wheel to make plunge cuts possible. Mount two left 45° opposite two right 45° teeth.
- All remaining outside pockets and all inside pockets require 45° teeth mounted away from wheel.
- The second pocket in each group gradually goes back into the cutter wheel for half a rotation and then repeats.

**OPTIONAL:
Razor Cutter Wheel**

- If the machine is supplied with the optional Razor cutter wheel, there are 48 teeth to a complete set. There are 16 outer Short Plow Bolt with Long Head Bits and 32 side Plow Bolt Bits.

CAUTION

Do not operate machine without a full set of teeth. Operating machine without a full set of teeth can cause excessive vibration and premature bearing failure.

- A locking pin is provided to hold cutter wheel in position during tooth removal and re-installation. The locking pin will only lock in the deep slots of the outer teeth. Line the slot up with the locking pin slot and insert the pin to lock position. The pin will need to be removed and reinserted as wheel is rotated to change remaining teeth.

CAUTION

Never place your hand on the cutter wheel to hold it in place while changing teeth. Be sure to remove the pin before operating the stump cutter.

- The teeth do not require a setting gauge. The only requirement is to be installed in the proper direction and tightened to the proper torque as discussed in the next section.

NOTE: When replacing a cutter wheel tooth, replace the tooth and nut as a set and use anti-seize on the threads.

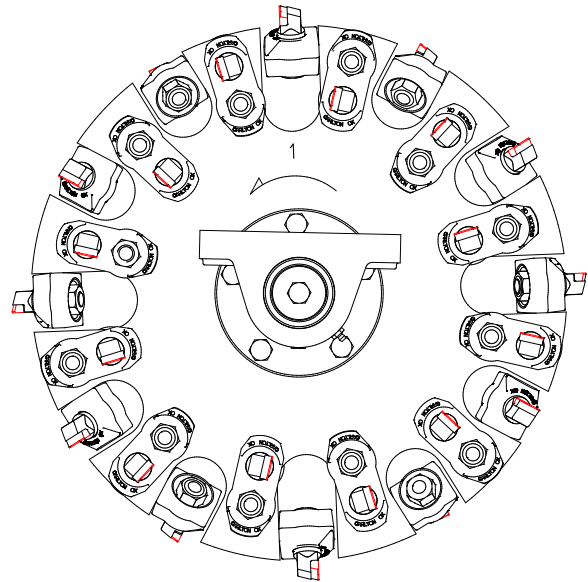

TOOTH ARRANGEMENT

- Inspect pockets, teeth and bolts for damage and replace as required.
- When replacing a cutter wheel tooth, replace the tooth and nut as a set and use anti-seize on the threads.
- When replacing teeth and pockets, also replace the teeth and pockets across from each other diagonally in order to maintain wheel balance and prevent vibration.
- All teeth and pockets are of a specific design and must be replaced with original manufacturer's replacement parts. Replacement teeth must be carbide tipped.
- When replacing complete set of teeth, be sure to duplicate original factory tooth arrangement. SEE DIAGRAM BELOW.
- The seating surfaces of the tooth and pocket are formed, but make sure the tooth is inserted with the carbide facing the direction of rotation.
- The pictured view is the engraved side of the wheel. The wheel is engraved with first (#1) outside pocket number and an arrow for the direction of rotation.
- Outside pocket teeth are Short Plow Bolt Bits. These pockets are angled and welded in place. Tip: To prolong tooth life, you can switch teeth from one outside pocket to a pocket that is the opposite direction. The cutting edge is the corner, and this will turn the opposite corner out for use.
- These teeth are tightened with nuts. Torque on nuts is not to exceed 170 ft/lbs.
- All teeth on cutter wheel sides are Plow Bolt Bits. When changing these teeth you must remove both teeth in the same pocket, one on each side of the wheel. When the nuts are torqued, the pocket is jammed and the teeth can only be removed this way.
- The pocket will receive wear when cutting and can be switched from one side of the cutter wheel to the other to prolong life. Remember the teeth must be replaced in the original position on each side of the wheel.

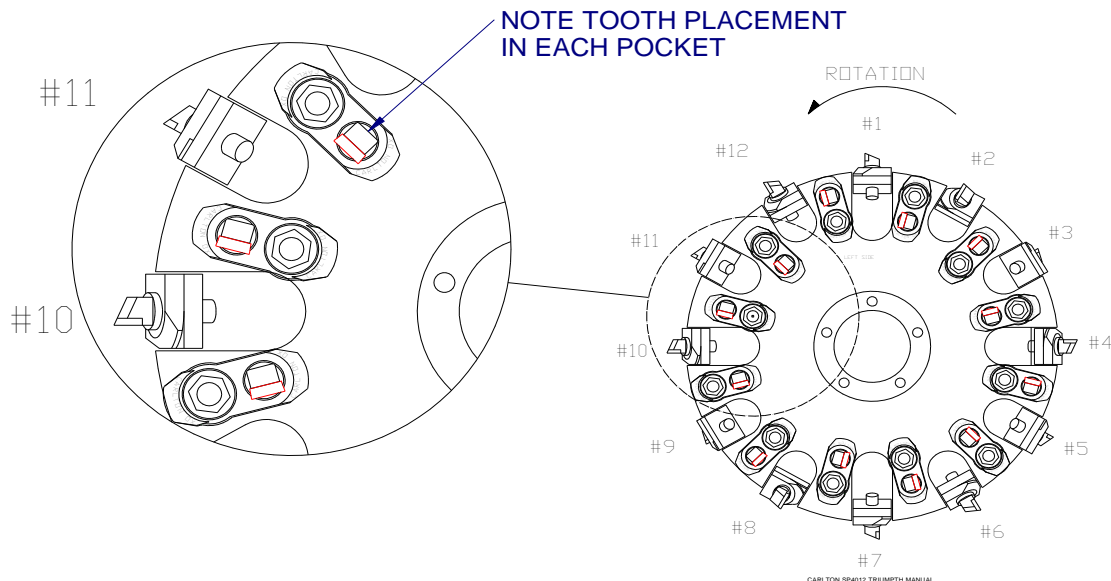

Note: It may be necessary to use a 1 1/4" hole saw to remove debris around nut to make tooth removal easier.

TOOTH SHARPENING

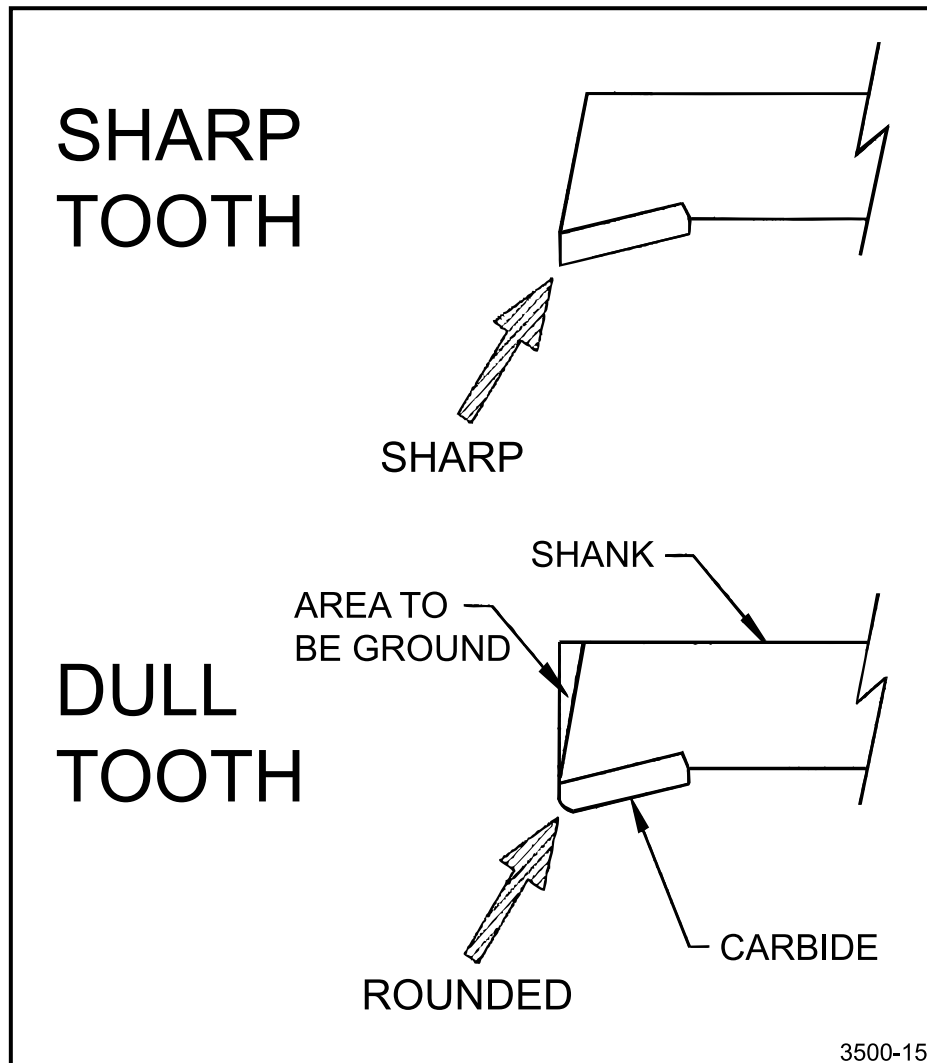

- Begin by chamfering shank back past edge of carbide. You do this because if it is not back far enough the shank will hit the stump instead of the carbide, thus causing a lot of vibration.
- Once the shank is angled far enough back, then begin sharpening carbide.
- **Cut shank with a standard rock and cut carbide with a silicone carbide or diamond rock.**

WARNING

Grinding carbide can be a health hazard. Use a proper facemask to help prevent inhaling harmful materials while grinding.

⚠ DANGER

More accidents occur while performing maintenance than any other time! Use extra caution!!
DO NOT PERFORM MAINTENANCE OF ANY KIND ON THIS MACHINE UNLESS:

- ◆ The engine is turned off.
- ◆ The ignition key has been removed.
- ◆ The positive battery cable has been disconnected.
- ◆ The cutter wheel is disengaged.
- ◆ All machine parts have come to a complete stop.
- ◆ All machine parts have had sufficient time to cool down.
- ◆ No operator is in position at the controls to accidentally start machine.
- ◆ At least 2 people are at the site where maintenance is performed.

- **RELEASE HYDRAULIC PRESSURE BEFORE PERFORMING ANY SERVICE TO HYDRAULIC LINES OR OTHER COMPONENTS.**
- **PLACE THE CUTTER WHEEL ON THE GROUND WHEN PERFORMING SERVICE ON A MACHINE.**

REPLACE HYDRAULIC OIL & FILTER

- For a new machine, replace filter after first 10 hours of operation. After that, at 200 hours increments. Replace with the same type of in-tank filter element supplied originally, available through Carlton or Carlton dealers.
- Unscrew tank reservoir cap and pull old filter out of housing and discard properly. Clean filter housing and install new filter, making sure old filter O-ring has been removed and new filter O-ring is in place. Push-in new filter until it is seated in housing cup. Replace reservoir cap and recheck oil level. Add oil as needed.
- Change hydraulic oil every 500 hours of operation or at least once a year depending on use. Flush the hydraulic tank when changing the hydraulic oil. Replace oil if it is very dark, contaminated, has a burnt odor, or if the machine has been stored for a long period of time. Note: Recommend Citgo AW32 hydraulic oil or equivalent.
- Drain the hydraulic tank using the drain plug located on the bottom of the tank. Dispose of used oil according to state regulations.



REPLACING ROD ENDS

- Should a rod end need replacing, loosen through bolt clamping rod end to cylinder rod and unscrew rod end.
- Reverse process to install new rod end. Tighten through bolt and use new cotter pins, and cylinder pins.



REPLACING BUSHINGS

- Hardened bushings have been incorporated into the machine to protect the main frame from wear and damage.
- Should a bushing need replacing, disconnect rod end from main frame and swing cylinder out of the way.
- Position new bushing directly above old bushing; gently tap new bushing down into position, displacing the old bushing.
- Swing cylinder back into position. Re-install rod end to main frame, using new pin assemblies.



REPLACING HYDRAULIC HOSES

- Place cutter wheel on ground before removing hydraulic hoses.
- It is not necessary to drain the hydraulic system to replace hoses.
- Loosen fitting and drain oil into suitable container for disposal. Remove old hose and replace with new one.
- Tighten fittings.
- Check for adequate supply of oil in tank before operating machine.



REPLACING HYDRAULIC PUMP

- Make sure that hydraulic oil is cool and that pressure is relieved from the lines.
- Disconnect hydraulic lines from pump and cap them.
- Remove bolts holding pump to engine.
- Replace pump and tighten bolts.
- Recheck oil supply in reservoir.



HYDRAULIC OIL COOLER

(only on remote control machines)

- A hydraulic oil cooler is installed on remote controlled machines to keep the hydraulic oil from overheating. There is a sensor in the bottom of the oil cooler which activates the cooling fan if the oil temperature rises to 140° or higher. Depending on the environment and the operation of the grinder, the fan may go on and off as the temperature of the oil fluctuates.
- Keep oil cooler fins clean. Use a garden hose and a mild detergent.



CAUTION

Do Not use a power washer as it may cause the fins to bend.

Do Not use an industrial strength detergent that may cause the metal to deteriorate.

- Inspect all connections and hoses for leaks and wear. Replace if necessary.

⚠ WARNING

Hydraulic oil is under pressure. Spraying fluid from a leak can burn or penetrate the skin and cause serious injury. If fluid penetrates the skin, immediately seek medical attention to have it surgically removed! **Always wear eye protection!**

⚠ DANGER

More accidents occur while performing maintenance than any other time! Use extra caution!!
DO NOT PERFORM MAINTENANCE OF ANY KIND ON THIS MACHINE UNLESS:

- ◆ The engine is turned off.
- ◆ The ignition key has been removed.
- ◆ The positive battery cable has been disconnected.
- ◆ The cutter wheel is disengaged.
- ◆ All machine parts have come to a complete stop.
- ◆ All machine parts have had sufficient time to cool down.
- ◆ No operator is in position at the controls to accidentally start machine.
- ◆ At least 2 people are at the site where maintenance is performed.

- **PLACE THE CUTTER WHEEL ON THE GROUND WHEN PERFORMING SERVICE ON A MACHINE.**

Replacing Engine Belt

- Remove engine belt guard cover, by removing the bolts that hold it on.
- To loosen the belt, use the engagement handle to slide the engine as far as it will go toward the cutter wheel.
- Once the belt is loose, around each sheave there are belt keepers, loosen and adjust to allow removal of belt. Install new belt then readjust and tighten belt keepers.



Replacing Engine Belt (cont.)

- Move the engagement lever to the full engaged position. Check belt tension and sheave alignment. (Refer to Machine Maintenance section, Checking Belt Tension.) The belt should deflect 1/2" with 25 lbs. of force centered between the sheaves.
- If any adjustment is required, there is a linkage assembly attached to the engagement lever. With the lever in the disengaged position, remove the yoke pin and adjust the yoke in or out as necessary to set the proper belt tension. **Note:** It may be necessary to loosen the jam nut to allow for proper adjustment.
- To tighten belt tension, adjust the yoke out (counterclockwise).
- To loosen belt tension, adjust the yoke in (clockwise).
- Replace yoke pin and move the lever to the engaged position.
- Recheck belt tension. Repeat until proper tension is achieved. Tighten jam nut if loose.
- Adjust slide lock lever as needed to ensure it locks properly when engagement handle is in the disengaged position.
- Replace cover and tighten all bolts.



LINKAGE ASSEMBLY ATTACHED TO ENGAGEMENT LEVER. REMOVE YOKE PIN AND ADJUST YOKE.

CAUTION

Do not over tighten belt; overly tight belts will cause bearing and engine damage. Replace belts when worn or when repeated adjustments are necessary. Belts should never get so loose that all the adjustment capability is used.

GENERAL TENSIONING OF V-BELT DRIVES

A few simple rules about tensioning will satisfy most of your requirements.

1. The best tension for the V-belt drive is the lowest tension at which the belt will not slip under the highest load condition.
2. Check tension on a new belt frequently during the first day of operation.
3. Thereafter, check belt tension periodically.
4. Too much tension shortens belt and bearing life.
5. Keep belts and sheaves free from any foreign material that may cause slippage.
6. If a V-belt slips, tighten it.

Replacing Poly Chain® Belt

Special care should be taken with your Poly Chain® belt. **Alignment, tension, and cleanliness** of this belt is very important. The Poly Chain® belt needs to be checked for tension every 70 to 100 hours of use. The Poly Chain® belt must be running true. If you adjust one bearing more than the other, the belt will run on an angle, which will cause belt failure. A belt broken straight across is the result of a shock load. In a shock load failure, the fibers are broken and over a period of time the belt will break down from the shock load and snap in half. A broken belt with lost teeth indicates that the belt was loose. When replacing the Poly Chain® belt, do not force the belt on over the sheave; this can break the fibers. After you have installed or re-tensioned the Poly Chain® belt, you will have to re-adjust the engine drive belt for proper tension.

- Remove the Poly Chain® guard cover and bottom cover.



- Loosen Poly Chain® belt by loosening the cutter wheel bearing bolts.

TIP: Mark the position of the bearing to aid in repositioning after the belt is replaced.



Replacing Poly Chain® Belt (cont.)

- Next, loosen the two front jam bolts on the underside of the boom box (one on each bearing) and move the cutter wheel toward the engine as far as possible. This will loosen the Poly Chain® belt.

TIP: Keep a count of how many turns you make on the jam bolts when loosening them, making the same number of turns on both jam bolts. This makes readjusting the Poly Chain® belt easier after replacement, tightening the jam bolts the same number of turns as you loosened them.

- Once the belt has been replaced, reverse the procedure to re-assemble the boom. Use the jam bolts on the cutter wheel bearings to adjust proper tension on the belt making sure to tighten or loosen them equally, keeping the sprockets aligned. Use a straight edge to check sprocket alignment after adjustments have been made. Refer to the Machine Maintenance section for how to Check Belt Tension and Belt Tension Adjustments for the Poly Chain Belt.
- Reposition front jam bolts against cutter wheel bearing and tighten. Readjust the jam nuts to lock bolt in position.
- Replace the Poly Chain® belt guard cover, bottom cover and tighten bolts.

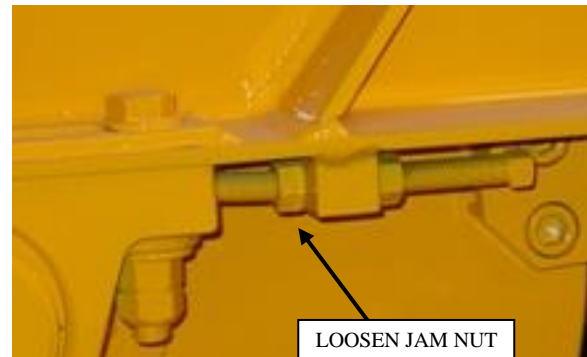
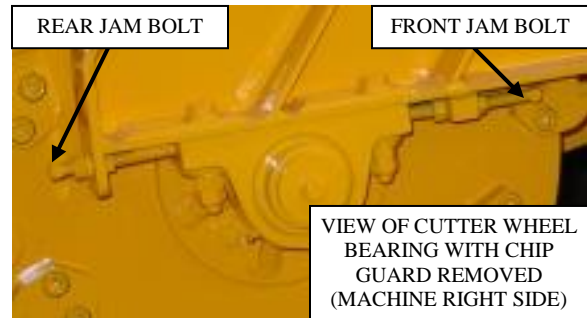

CAUTION

Never Operate Machine Without Belt Guard Covers in Place and Properly Secured. Check All Bolts for Tightness.

⚠ DANGER

More accidents occur while performing maintenance than any other time! Use extra caution!!
DO NOT PERFORM MAINTENANCE OF ANY KIND ON THIS MACHINE UNLESS:

- ◆ The engine is turned off.
- ◆ The ignition key has been removed.
- ◆ The positive battery cable has been disconnected.
- ◆ The clutch is disengaged.
- ◆ All machine parts have come to a complete stop.
- ◆ All machine parts have had sufficient time to cool down.
- ◆ No operator is in position at the controls to accidentally start machine.
- ◆ At least 2 people are at the site where maintenance is performed.

- **PLACE THE CUTTER WHEEL ON THE GROUND WHEN PERFORMING SERVICE ON A MACHINE.**
- **ALWAYS CLEAN TIP OF GREASE GUN FITTING AND GREASE FITTING ON MACHINE BEFORE ATTACHING HOSE TO PREVENT DIRT FROM BEING FORCED INTO MACHINE PARTS.**

JACKSHAFT BEARINGS

- There are four (4) bearings on the jackshaft; two (2) mounted on the inside of the supports and two (2) mounted on the outside of the supports. These bearings should be greased daily to keep dirt and moisture out. These bearings should not be purged, only use 2 to 4 shots of grease.
PROPER MAINTENANCE IS CRITICAL TO ENSURE LONG BEARING LIFE.

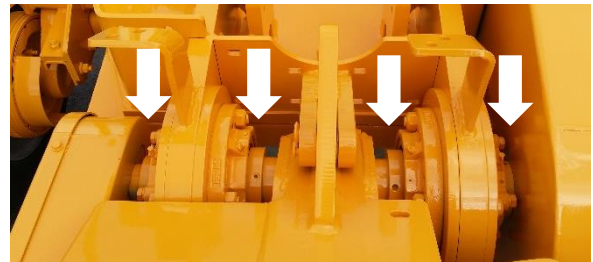
**CUTTER WHEEL BEARINGS**

- There are two (2) bearings on the cutter wheel shaft. These bearings should be purged using grease **EVERYDAY**. Purge until new grease is seen to keep dirt and moisture out.
PROPER MAINTENANCE IS CRITICAL TO ENSURE LONG BEARING LIFE.

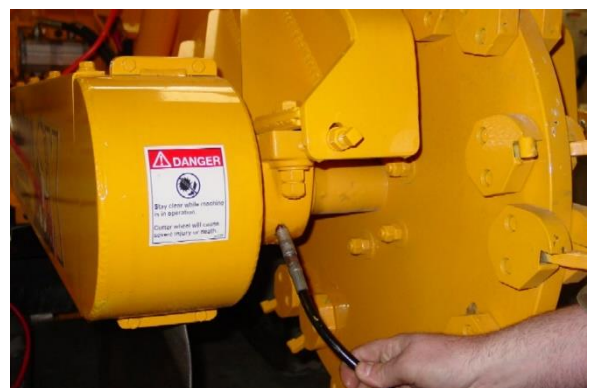

SERVICING TURNTABLE BEARING

While turntable bearings require almost no attention, what little they are given will pay big dividends in long life, high performance, and trouble-free service. Lubricate the bearing every 100 operating hours for relatively slow rotating applications. Idle equipment should not be neglected. Grease dries out and temperature changes can cause condensation within the bearing. Whether used or not, the bearing should have grease introduced every 6 months. It is always a good idea to rotate the bearing a few turns to coat all surfaces with fresh grease. Also inspect seals, making certain that they are in proper position in grooves and intact. Check tightness of mounting bolts and retighten if needed. Be alert to changes in rotation, unusual sounds, and vibrations.

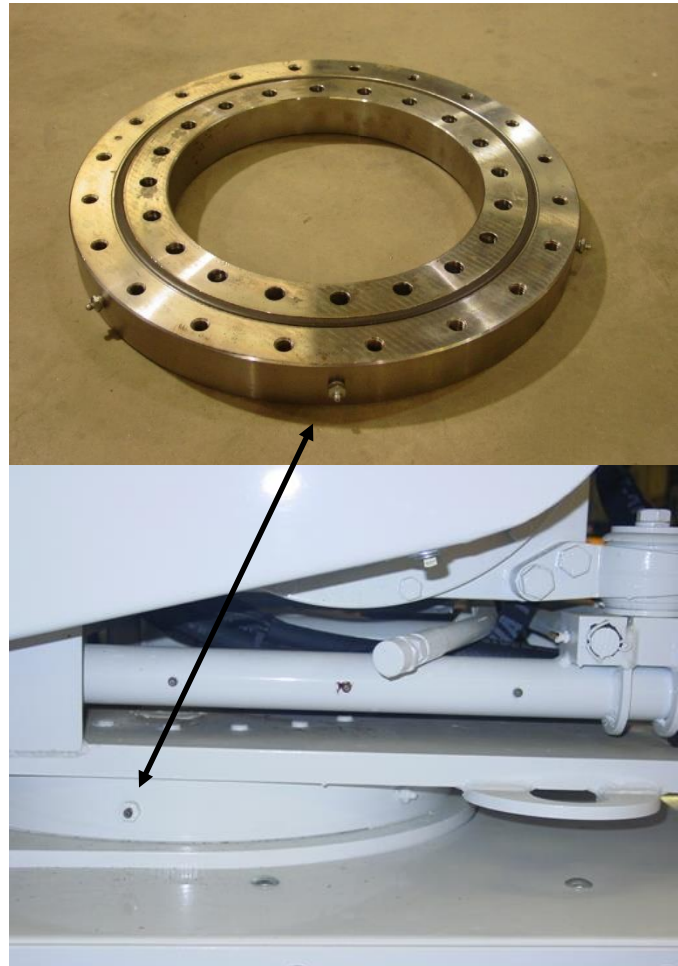

NOTICE

This machine is lubed with Starplex II grease when it is delivered from the factory. Starplex II is lithium complex soap grease, which contains a specially formulated additive package to provide excellent rust protection, resistance to water washout and extreme pressure properties. It is recommended as multipurpose, high performance grease for severe duty industrial applications involving high temperatures, water contamination and shock loading. Operating temperature range is from -22°F to 284°F.

⚠ DANGER

More accidents occur while performing maintenance than any other time! Use extra caution!!
DO NOT PERFORM MAINTENANCE OF ANY KIND ON THIS MACHINE UNLESS:

- ◆ The engine is turned off.
- ◆ The ignition key has been removed.
- ◆ The positive battery cable has been disconnected.
- ◆ The clutch is disengaged.
- ◆ All machine parts have come to a complete stop.
- ◆ All machine parts have had sufficient time to cool down.
- ◆ No operator is in position at the controls to accidentally start machine.
- ◆ At least 2 people are at the site where maintenance is performed.

- **PLACE THE CUTTER WHEEL ON THE GROUND WHEN PERFORMING SERVICE ON A MACHINE.**
- **ALWAYS CLEAN TIP OF GREASE GUN FITTING AND GREASE FITTING ON MACHINE BEFORE ATTACHING HOSE TO PREVENT DIRT FROM BEING FORCED INTO MACHINE PARTS.**

- The most service you should have to do for the **bearing supported stub shaft** is to grease it properly. There is a grease fitting on the end of the stub shaft to grease the splines in the coupling. Follow the instructions in the Machine Maintenance section for frequency and application of grease. Also see the Lubrication Chart.

REPLACE STUB SHAFT

- Remove the V-belt following the instructions in the Servicing Belt Section of the manual.
- Remove the engine belt keepers instead of just loosening the bolts and lay aside to put on new stub shaft plate assembly.



REPLACE STUB SHAFT (CONT.)

- Remove the jackshaft sheave. Remove the bolts in the jackshaft sheave and screw them back into the empty threaded holes to push the sheave off the bushing and remove the bushing and sheave. Make sure to keep all machine parts and hardware together to make reassembly easier.



- Remove the bolts holding the belt guard onto the machine and remove the belt guard.

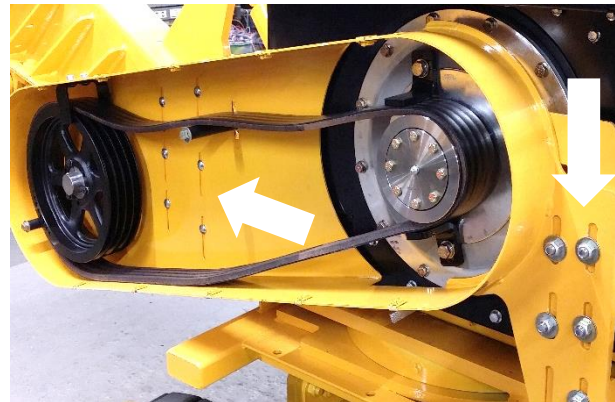

- Remove engine sheave by first removing bolts on outer stub shaft plate.
*(5/16-18 x 3/4" bolt, use 1/2" socket).

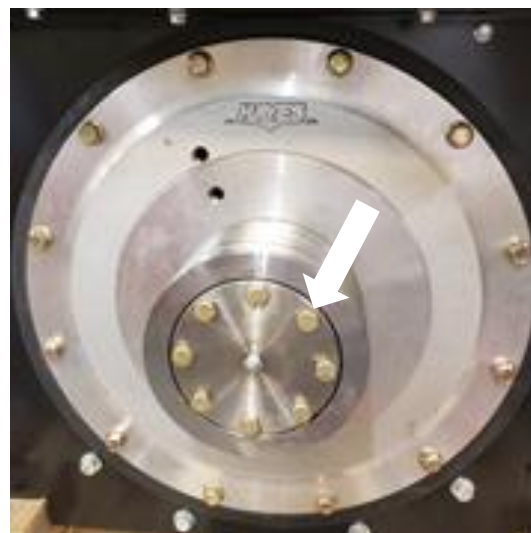

REPLACE STUB SHAFT (CONT.)

- Pull stub shaft out of the bearing sleeve.

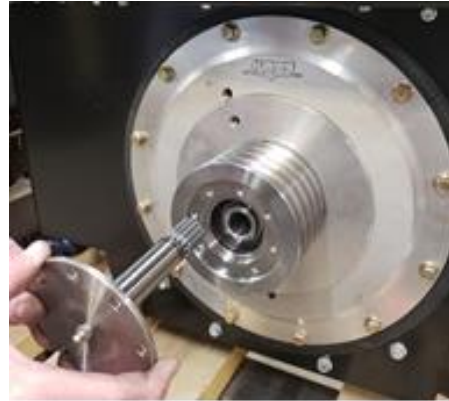

- Remove the snap ring and remove sheave.



- Inspect bearing sleeve for grooves or burrs. Replace if needed. **Note:** if worn, it is recommended to replace the complete kit (bell housing, bearing sleeve and coupling plate) to avoid future damage and expense!

- To remove the bearing sleeve and to access the coupling plate, remove the bolts around the outside of the bell housing.
*(3/8-16 x 1/4" bolt, use 9/16" socket)

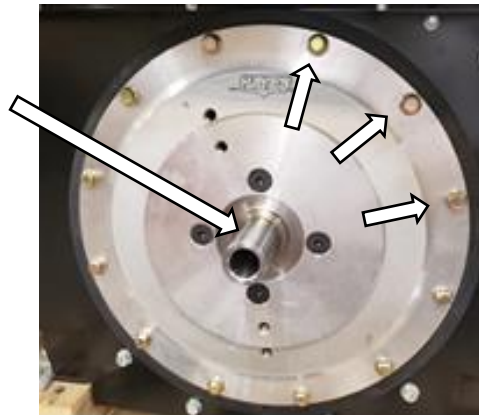

- Inspect and replace any parts found defective or worn. Replace coupling plate if damaged.
- Prior to reinstalling the coupling plate, apply anti-seize (coupling lubricant) to the inside (ID) of the coupling.
- Line up external splines with the coupling ID and slide the coupling plate into place.

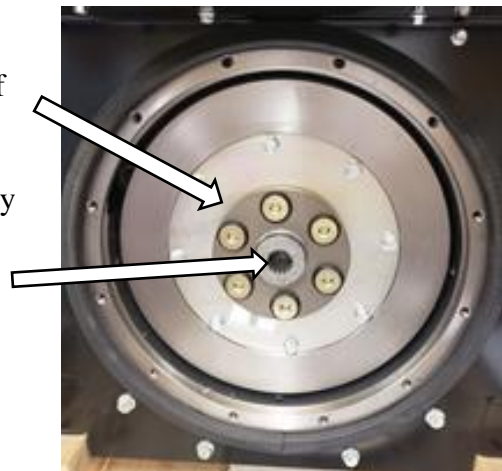

REPLACE STUB SHAFT (CONT.)

- Replace bolts around the outside of the coupling plate. Apply LocTite 242 (blue).
*(3/8-16 x 1/4" bolt, use 9/16" socket)

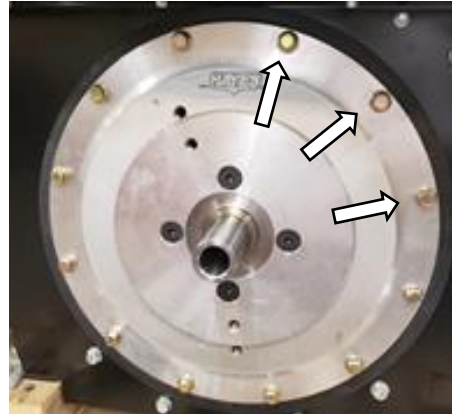

- Replace sheave and snap ring.



- Apply anti-seize to outside diameter of stub shaft splines. Insert stub shaft into bearing sleeve.

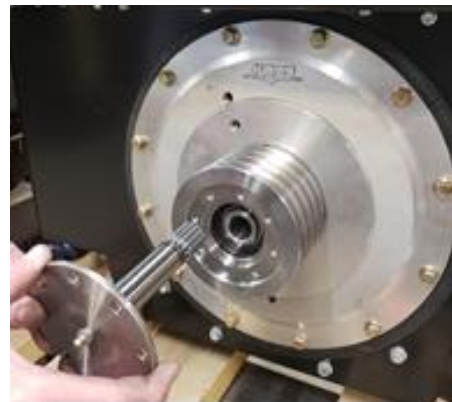

- Replace bolts around the outer sheave plate. Apply LocTite 242 (blue).
*(5/16-18 x 3/4" bolt, use 1/2" socket).

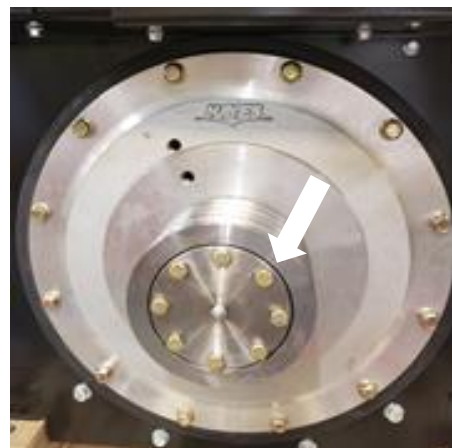

REPLACE STUB SHAFT (CONT.)

- Replace the belt guard housing.
- Replace V-belt and align the sheaves as instructed in the Servicing Belt Section of this manual. Adjust sheaves as necessary to get the proper belt alignment. Check belt tension and set as described in Servicing Belt section. Belt alignment and tension are very important for long bearing life.

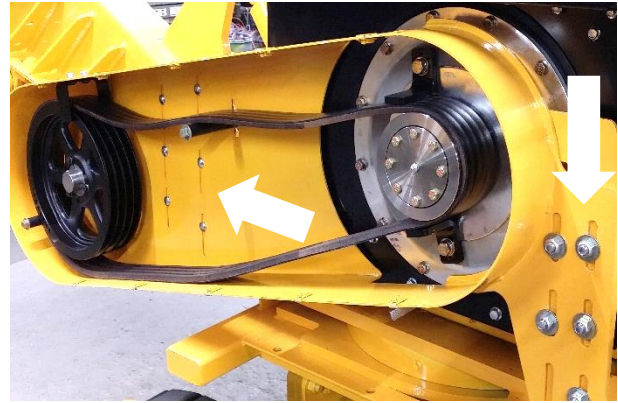

- Grease stub shaft bearing at the grease fitting on the end of the shaft. Wipe off excess grease.
NOTE: Excess grease will attract dirt. **DO NOT** over grease, over greasing could cause a hydraulic type lift on seals.
- Follow the instructions in the Machine Maintenance section for frequency and application of grease. Also see the Lubrication Chart.
- Replace belt guard cover.

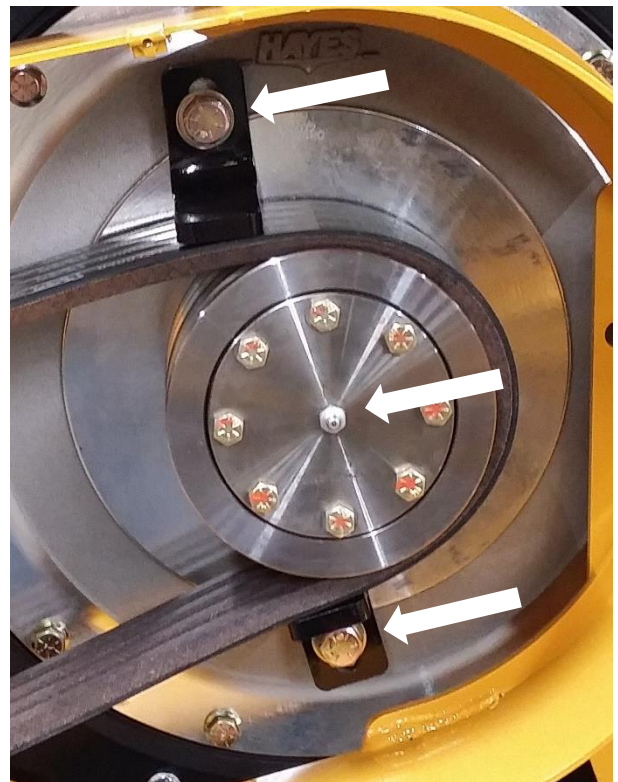
**CAUTION**

**Never Operate Machine Without Belt Guard Covers in Place and Properly Secured.
Check All Bolts for Tightness.**

⚠ DANGER

More accidents occur while performing maintenance than any other time! Use extra caution!!
DO NOT PERFORM MAINTENANCE OF ANY KIND ON THIS MACHINE UNLESS:

- ◆ The engine is turned off.
- ◆ The ignition key has been removed.
- ◆ The positive battery cable has been disconnected.
- ◆ The clutch is disengaged.
- ◆ All machine parts have come to a complete stop.
- ◆ All machine parts have had sufficient time to cool down.
- ◆ No operator is in position at the controls to accidentally start machine.
- ◆ At least 2 people are at the site where maintenance is performed.

REAR END

- The 9” limited slip rear end on the machine requires almost no maintenance once it is lubricated and in service. Inspect on a monthly basis for any leaks or damage from flying debris from the cutter wheel. Put machine on level ground and remove plug and make sure that gear lube is level with the bottom of the plugs hole. If lube is needed, use 85W-140 gear lube.

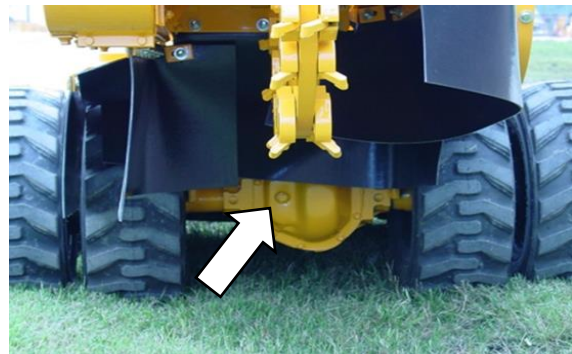

REAR END COUPLING SAFETY NUT

- The rear end jaw coupling and the drive motor couple are secured using a onetime use safety nut. If required to replace either coupling, you must replace the safety nut.

1	0150211A	Nut, Hex, Autolock, 3/4”-16
2	0300043A	Nut, Hex, Security Lock, 1”-20

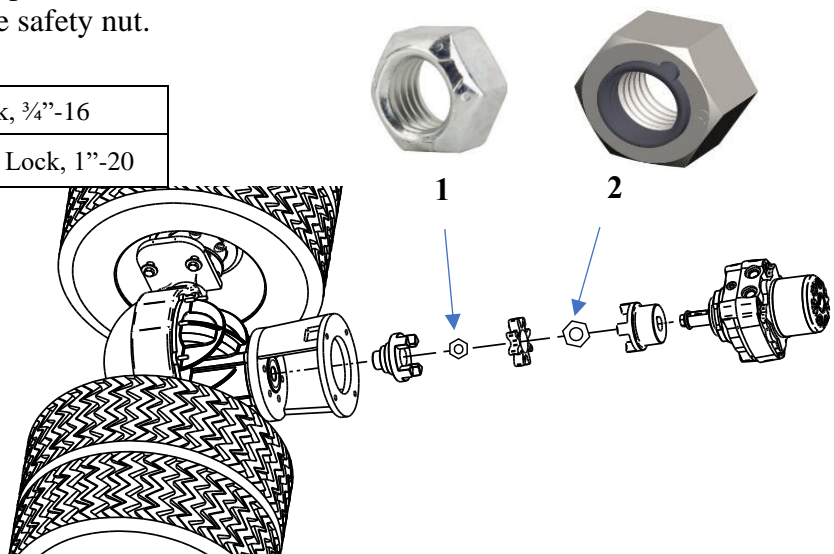

CAUTION

Do not reuse the rear end or drive motor coupling safety nut if required to remove for service!! Install a new safety nut to avoid damaging the threads which will lead to a more serious and costly failure when under normal operating conditions.

BLANK SHEET

CARLTON
PARTS & SERVICE



CARLTON STANDS FOR QUALITY!!

Carlton's certified service department, along with its authorized dealer network, can help you keep your stump cutter or wood chipper working at its best. *Your authorized J.P. Carlton dealer knows your local conditions and is ready to deliver fast, professional, and expert service and/or parts, when you need it most.*

Visit our website to find a dealer near you.

www.stumpcutters.com

(800) 243-9335

(864) 578-9335

ATTENTION:

Please have the machine Model and Serial Number available when contacting one of our parts and service professionals.

STUMP CUTTERS

Model	Engine		Length		Width				Height		Weight	
	[hp]	[kw]	[in]	[cm]	Minimum		Maximum		[in]	[cm]	[lbs]	[kg]
					[in]	[cm]	[in]	[cm]				
900H	13	9.69	77	195.58	24	60.96	25	63.50	44	111.76	220	99.79
SP2000	27	20.13	80	203.20	29	73.66	29	73.66	54	137.16	700	317.51
SP5014	35	26.10	103	261.62	35	88.90	35	88.90	57	144.78	1650	748.43
	37	27.59									1650	748.43
SP5014 TRX	35	26.10	103	261.62	35	88.90	35	88.90	56	142.24	2215	1004.71
	37	27.59									2215	1004.71
SP6016	54	40.27	126	320.04	34.5	87.63	34.5	87.63	50	127	3200	1451.50
SP7015	74	55.18	140	355.60	35	88.90	52	132.08	76	193.04	4520	2050.24
SP7015 TRX	74	55.18	130	330.20	35	88.90	48	121.92	77	195.58	5820	2639.91
SP7015 TRX HD	74	55.18	151	383.54	35	88.90	48	121.92	77	195.58	6400	2902.99
SP8018 TRX	116	86.50	166	421.64	60	152.40	60	152.40	83	210.82	8600	3900.89
HURRICANE RS	140	104.40	200	508.00	72	182.88	72	182.88	96	243.84	10100	4581.28
	173	129.01									11380	5161.88
HURRICANE TRX	173	129.01	200	508.00	72	182.88	72	182.88	96	243.84	13520	6132.57
7500	74	55.18	180	457.20	84	213.36	84	213.36	70	177.8	6430	2916.60

WOOD CHIPPERS

Model	Engine		Length		Width				Height		Weight	
	[hp]	[kw]	[in]	[cm]	Minimum		Maximum		[in]	[cm]	[lbs]	[kg]
					[in]	[cm]	[in]	[cm]				
660	27	20.13	124	314.96	56	142.24	56	142.24	87	220.98	1740	789.25
1260	35	26.10	132	335.28	68.5	173.99	68.5	173.99	89	226.06	2620	1188.41
	37	27.59									2620	1188.41
1290	35	26.10	144	365.76	68.5	173.99	68.5	173.99	89	226.06	2930	1329.03
	37	27.59									2930	1329.03
	54	40.27									3700	1678.29
1712	74	55.18	198	502.92	70	177.80	70	177.80	101	256.54	6500	2948.35
	80	59.66									5800	2630.84
	135	100.67									6920	3138.86
2012	116	86.50	196	497.84	80	203.20	80	203.20	104	264.16	7760	3519.88
	135	100.67									7000	3519.88
	140	104.40									7760	3519.88
2018	173	129.01	240	609.60	88	223.52	88	223.52	108	274.32	12400	5624.55
1712 APACHE	74	55.18	198	502.92	70	177.80	70	177.80	101	256.54	6920	3138.86
	135	100.67									6820	3093.50
2015 APACHE	116	86.50	244	619.76	90.5	229.87	90.5	229.87	108	274.32	9050	4105.01
	140	104.40									9900	4490.56
	180	134.23									8800	3991.61
2518 APACHE	140	104.40	245	622.30	90	228.60	90	228.60	114	289.56	11300	5125.59
	173	129.01									11300	5125.59
	180	134.23									10300	4672.00

MULTIPLE COLOR OPTIONS AVAILABLE