



## OPERATION

- 1)  Remove the rotary hoe from its trailer. Use caution.
- 2) Familiarize yourself with the machine and its controls.
- 3) Ensure all clutch controls are in the "disengaged" position. The engine safety clutch lever is located on the left handle bar (from rear) of the machine. The disengage position of the engine lever is down. The wheel shift lever is closest to operator (from rear) and the rotor shift lever is forward (away from operator) of the wheel shift lever (from rear). Both levers are located on the right side of the machine (from rear). The disengage position of both the wheel and rotor shift levers is locked in towards the machine. Both levers are held in place with locking hooks.
- 4) **DEPTH SHOE ADJUSTMENT**  
Control the depth of the hoe with the depth control bar at the rear of the machine. The higher the bar is set, the deeper the hoe will dig. It is recommended that the initial setting be in the centre hole for the first pass. Lower holes may then be used to achieve full hoe depth. Where the ground is extremely hard try the following technique. (a) Soak the ground with water the day before you intend to do the designated area. (b) Use the centre hole on the depth control bar at all times. (c) Pass over the ground in a clockwise or anticlockwise direction. (d) Proceed corner to corner in a diagonal direction. (e) Repeat step (d) in the opposite direction.
- 5)  Open fuel shut-off valve, if engine is equipped. Move choke control to CHOKE or START position.

Note: Choke must fully close. Move throttle control to RUN or FAST position.

If engine is equipped with rocker style stop switch, push RUN or I (I = Ignition) before starting. Rewind Starter: Grasp rope

handle and pull slowly until resistance is felt to prevent kickback. Then pull cord rapidly to overcome compression, and start engine. Repeat if necessary with choke off and throttle control in FAST position. Operate engine in FAST position.

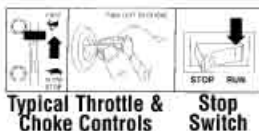

- 6) Engage the wheel drive. Unlock retaining hook and pull lever away from machine. Engage engine clutch by lifting up on handle. The hoe will begin to move forward. **Use engine clutch to start and stop while Rotary Hoeing.**
- 7) When in position to begin rotary hoeing, disengage engine clutch lever. The hoe will stop. Engage the rotor shift lever. Unlock retaining hook and pull lever away from machine. Lift the engine clutch lever. The hoe will begin to move forward AND the blades will turn.
- 8) Do not hurry the job. Proceed slowly and give the machine time to do the job properly. When ground is extremely hard, reduce engine speed. Once again we must emphasise the need to water the area thoroughly and allow sufficient time for the earth to soften.



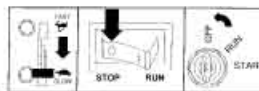

**WARNING! – KEEP HANDS AND FEET CLEAR OF TYNES AT ALL TIMES!**

- 9)  **WARNING! – IN CASE OF DIFFICULTY, DISENGAGE THE SAFETY CLUTCH LEVER. ALL HOEING ACTION STOPS. Press the engine "STOP" button located on the engine. (See illustration)**
- 10) **Stop Engine:** Do not move choke control to CHOKE position to stop engine. Backfire or engine damage may occur. Move throttle control to SLOW position, then push rocker switch to 0 (STOP), or turn key to OFF, if equipped.



Typical Stop Switches

## AFTER USE

- 1)  Turn fuel tap to "OFF" position.
- 2)  Allow machine to cool down. Wash mud and dirt off of the hoe. Ensure no water enters the carburettor.
- 3) Remove any weeds, wire, rope, etc. that may have wrapped around the knives and rotor assembly.



# SAFETY PRECAUTIONS AND OPERATING INSTRUCTIONS

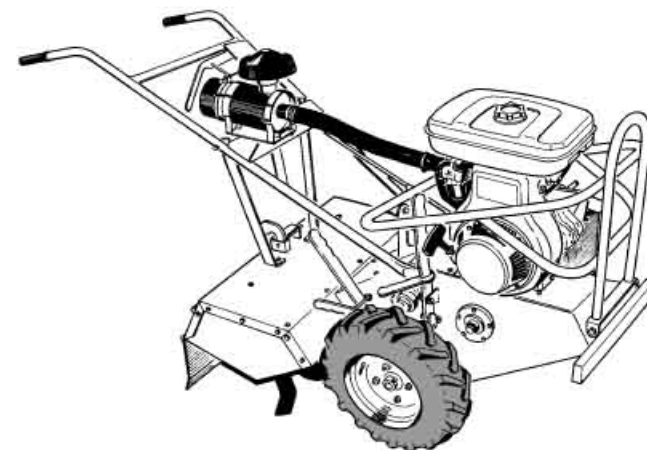



## RH2000-3 ROTARY HOE





 **REDROO.com**  
Commercial Outdoor Power Equipment

# SAFETY PRECAUTIONS FOR RH2000-3 USERS

## **USE COMMON SENSE AND PLENTY OF IT**

- 1)  **DO NOT** allow any person to operate the rotary hoe without first reading and understanding the safety precautions and operating instructions. **KNOW THE CONTROLS AND HOW TO STOP THE ROTARY HOE QUICKLY IN AN EMERGENCY.**
- 2) **NEVER** allow children or untrained adults to operate the rotary hoe.   
- 3) **ALWAYS** wear protective clothing when operating the rotary hoe. This includes, but is not limited to; safety glasses, loose fitting gloves, steel capped boots and hearing protection. **NEVER** wear loose fitting clothing or jewellery when operating the rotary hoe. Keep all clothing away from moving parts. Items could become caught in the machine, resulting in injury.
- 4) **ALWAYS** operate the rotary hoe in a well lighted area.
- 5) **ALWAYS** make certain that all three control clutches are in the "disengaged" position prior to starting the engine.
- 6)  **ALWAYS** operate rotary hoe on level ground only. Police the area before rotary hoeing. Remove any foreign objects in the digging area eg bricks, rocks, wire and sticks. Locate and mark any sprinkler heads, water pipes, gas lines, electrical and telephone cables or any other hazard either below or above ground.
- 7)  **DO NOT** allow other persons near the rotary hoe. It is up to the operator to keep bystanders and animals a minimum of 6 metres (18ft) away from the machine while in operation.
- 8) **NEVER** operate the rotary hoe when fatigued. **ALWAYS BE ALERT!** If you get tired while operating the rotary hoe, take a break. If you have any type of physical or mental condition

that may be aggravated by strenuous work, consult with your physician before you operate this equipment. **NEVER** operate the rotary hoe under the influence of medication, alcohol or drugs.

- 9)  **ALWAYS KEEP YOUR HANDS, FEET AND BODY AWAY FROM THE DIGGING AREA WHILE ENGINE IS RUNNING.**
- 10)  **NEVER** operate the unit without the safety guards in place and in working order. Keep the unit well maintained and in good working order
- 11) **DO NOT** leave the machine unattended while the engine is running.
- 12) **DO NOT** overspeed the engine or alter the governor settings. Excessive speed is dangerous and will shorten engine life.
- 13)  **NEVER** operate the rotary hoe in an enclosed area. Engine exhaust contains carbon monoxide, an odourless and tasteless poison.
- 14)  **STOP** the engine and disconnect the spark plug lead(s) and allow engine to cool before inspecting or performing maintenance on the rotary hoe.
- 15)  **REFUELLING**
  - \* Shut off engine. **DO NOT REFUEL AN ENGINE WHILE OPERATING!**
  - \* Allow engine to cool. Minimum 5 minutes.
  - \* **USE UNLEADED FUEL ONLY. Use clean, fresh unleaded fuel.**
  - \* **Do not mix oil with unleaded fuel.**
  - \* Do not over-fill fuel tank. Allow space for fuel expansion.
  - \* Do not smoke.
  - \* Allow no naked flame or hot material in refuelling area.
  - \* Use only approved fuel containers and funnels. Remember, fuel is a potential hazard.

## "STAY ALERT – DON'T GET HURT"

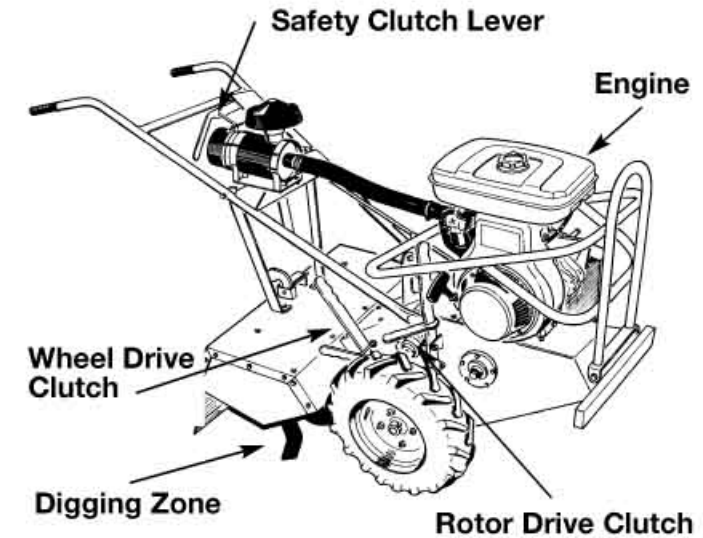



## **OPERATING INSTRUCTIONS**

### TRANSPORT

The depth control bar is to be placed in its lowest possible position. This will provide sufficient clearance to prevent damage to the rotor assembly.

### BEFORE USE

- 1) Ensure that all grass and weeds have been cut as low as possible.
- 2) If the rotary hoe is to be used in clay or hard ground conditions, it is recommended to water the area thoroughly and allow sufficient time for the earth to soften.
- 3)  Police the area. Remove any foreign objects from the area.
- 4)  Identify and mark the location of sprinkler heads, gas pipes, telephone cables, etc.